



LM Roller

THK General Catalog

A Product Descriptions

Features and Types	A10-2
Features of the LM Roller	A10-2
• Structure and Features	A10-2
Types of the LM Roller	A10-4
• Types and Features	A10-4
Point of Selection	A10-6
Nominal Life	A10-6
Accuracy Standards	A10-9
Dimensional Drawing, Dimensional Table	
Models LR and LR-Z	A10-10
Models LRA and LRA-Z	A10-11
Models LRB and LRB-Z	A10-12
Model LRU	A10-13
Point of Design	A10-14
Raceway	A10-14
Installing the LM Roller	A10-15
Guidance for Adjusting the Clearance ..	A10-16
Examples of Arranging LM Roller Units..	A10-17
Examples of Installing the LM Roller..	A10-18
Options	A10-19
Spring Pad Model PA	A10-19
Fixture Models SM/SMB and SE/SEB..	A10-22
• Fixtures Models SM/SMB	A10-23
• Fixtures Models SE/SEB	A10-24
Model No.	A10-25
• Model Number Coding	A10-25
• Notes on Ordering	A10-25
Precautions on Use	A10-26

B Support Book (Separate)

Features and Types	B10-2
Features of the LM Roller	B10-2
• Structure and Features	B10-2
Types of the LM Roller	B10-4
• Types and Features	B10-4
Point of Selection	B10-6
Nominal Life	B10-6
Mounting Procedure	B10-9
Installing the LM Roller	B10-9
Examples of Installing the LM Roller..	B10-10
Model No.	B10-11
• Model Number Coding	B10-11
• Notes on Ordering	B10-11
Precautions on Use	B10-12

Features of the LM Roller

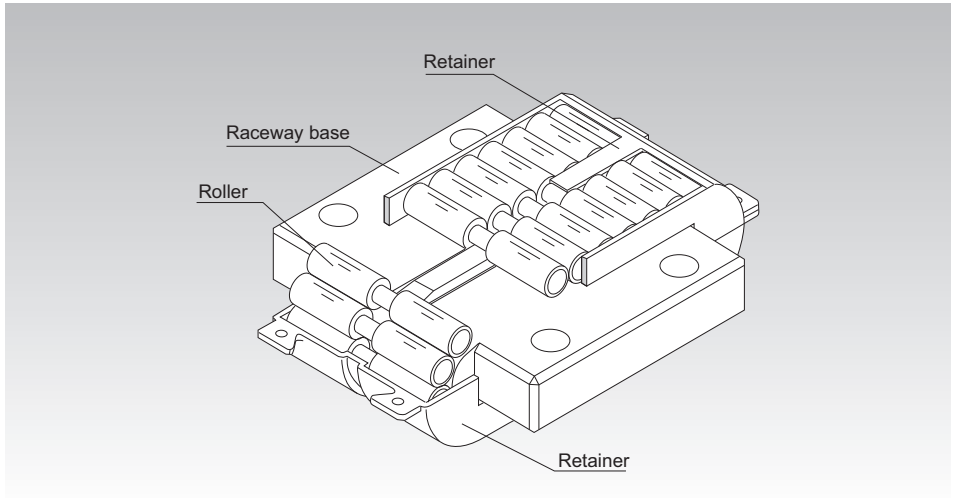

Fig.1 Structure of LM Roller Model LR

Structure and Features

In the LM Roller, dual rollers assembled on the circumference of the precision-ground, rigid raceway base travel in infinite circulation while being held by a retainer. A center guide integrated with the raceway base is formed in the central part of the loaded area of the raceway base to constantly correct skewing of the rollers. This unique structure ensures smooth rolling motion. The LM Roller is used in applications such as the XYZ guide of NC machine tools, precision press ram guides, press dies changers and heavy-load conveyance systems.

Features and Types

Features of the LM Roller

[Supports an Ultra Heavy Load and Ensures Smooth Motion]

The LM Roller is compact and capable of carrying a heavy load, and one unit of model LR50130 (length: 130 mm; width: 82 mm; height: 42 mm) is capable of receiving a 255 kN load. Moreover, because of rolling motion, this model has a low friction coefficient ($\mu = 0.005$ to 0.01) and is free from stick-slip, thus achieving highly accurate straight motion.

[High Combined Accuracy]

In general, when supporting a single plane with LM rollers, multiple units of LM rollers are combined on the same plane, and therefore, the height difference between the rollers significantly affects the machine accuracy and service life. With THK LM Roller, the user can select a combination of models with a height difference of up to $2 \mu\text{m}$.

[Rational Skewing-preventing Structure]

With an LM system using rollers, once the rollers skew, it increases friction resistance or decreases running accuracy.

To prevent skewing, the LM Roller has roller guides on the center of the retainer full circle, and in the center of the loaded area on the raceway base. This structure enables the LM Roller to automatically correct skewing caused by a mounting accuracy error and the rollers to travel in an orderly manner. It also allows the LM Roller to be installed with slant mount or wall mount while demonstrating high performance.

Types of the LM Roller

Types and Features

Model LR

This model is designed to be fit into a groove machined on the mounting surface. By screwing bolts into four holes on the raceway base, it is secured on the mounting surface. (Fixture models SM and SE are also available.)

Specification Table⇒ **A10-10**

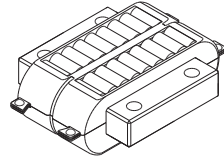

Model LR

Model LR-Z

A lighter type that uses a resin retainer and is designed to be mounted in the same manner as model LR. Since it has a groove for installing a seal, a special rubber seal with a high contamination protection effect can easily be attached. In addition, this model is capable of high-speed traveling at 1 m/s.

Specification Table⇒ **A10-10**

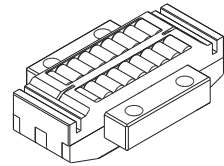

Model LR-Z

Model LRA

Just like model LR, this model is also designed to be fit into a groove. It is a compact type that can be mounted using fixture model SM or SE and bolts.

Specification Table⇒ **A10-11**

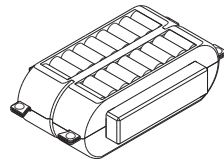

Model LRA

Model LRA-Z

A lighter type that uses a resin retainer and is designed to be mounted in the same manner as model LRA. Since it has a groove for installing a seal, a special rubber seal with a high contamination protection effect can easily be attached. In addition, this model is capable of high-speed traveling at 1 m/s.

Specification Table⇒ **A10-11**

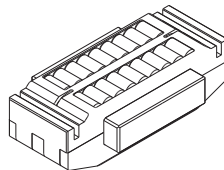

Model LRA-Z

Model LRB

Since this model does not require a groove on the mounting surface, man-hours for machining can be reduced. It can be mounted using fixture model SMB or SE and bolts.

Specification Table⇒ **A10-12**

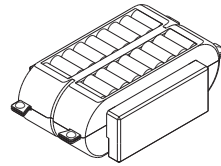

Model LRB

Model LRB-Z

A lighter type that uses a resin retainer and is designed to be mounted in the same manner as model LRB. Since it has a groove for installing a seal, a special rubber seal with a high contamination protection effect can easily be attached. In addition, this model is capable of high-speed traveling at 1 m/s.

Specification Table⇒ **A10-12**

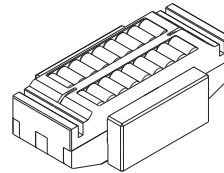

Model LRB-Z

Model LRU

Since this model does not require a groove on the mounting surface, man-hours for machining can be reduced. By screwing bolts into four holes on the raceway base, it is secured on the mounting surface.

Specification Table⇒ **A10-13**

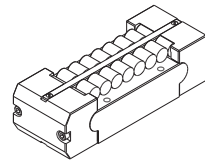

Model LRU

Nominal Life

[Static Safety Factor f_s]

The LM Roller may receive an unexpected external force while it is stationary or operative due to the generation of an inertia caused by vibrations and impact or start and stop. It is necessary to consider a static safety factor against such a working load.

$$f_s = \frac{f_c \cdot C_0}{P_c}$$

f_s : Static safety factor

f_c : Contact factor

(see Table2 on **A10-8**)

C_0 : Basic static load rating (kN)

P_c : Calculated load (kN)

● Reference Value of Static Safety Factor

The static safety factors indicated in Table1 are the lower limits of reference values in the respective conditions.

Table1 Reference Value of Static Safety Factors (f_s)

Machine using the LM system	Load conditions	Lower limit of f_s
General industrial machinery	Without vibration or impact	1 to 1.3
	With vibration or impact	2 to 3
Machine tool	Without vibration or impact	1 to 1.5
	With vibration or impact	2.5 to 7

[Nominal Life]

The nominal life of the LM Roller is obtained using the basic dynamic load rating (C) indicated in the corresponding specification table, and the following equation.

$$L = \left(\frac{f_H \cdot f_C \cdot f_T}{f_W} \cdot \frac{C}{P_C} \right)^{\frac{10}{3}} \times 100$$

- L : Nominal life (km)
 (The total number of revolutions that 90% of a group of identical LM Roller units independently operating under the same conditions can achieve without showing flaking)
- C : Basic dynamic load rating (kN)
- P_C : Calculated radial load (kN)
- f_H : Hardness factor (see Fig.1)
- f_T : Temperature factor
 (see Fig.2 on **A10-8**)
- f_C : Contact factor
 (see Table2 on **A10-8**)
- f_W : Load factor (see Table3 on **A10-8**)

[Calculating the Service Life Time]

When the nominal life (L) has been obtained, if the stroke length and the number of reciprocations per minute are constant, the service life time is obtained using the following equation.

$$L_h = \frac{L \times 10^6}{2 \times l_s \times n_1 \times 60}$$

- L_h : Service life time (h)
- l_s : Stroke length (mm)
- n₁ : Number of reciprocations per minute (min⁻¹)

● f_H: Hardness Factor

To maximize the load capacity of the LM system, the hardness of the raceways needs to be between 58 to 64 HRC. If the hardness is lower than this range, the basic dynamic load rating and the basic static load rating decrease. Therefore, it is necessary to multiply each rating by the respective hardness factor (f_H).

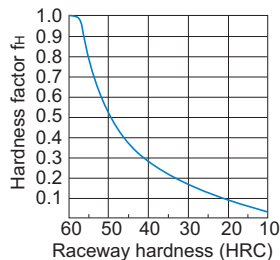

Fig.1 Hardness Factor (f_H)

● f_t : Temperature Factor

If the temperature of the environment surrounding the operating LM Roller exceeds 100°C, take into account the adverse effect of the high temperature and multiply the basic load ratings by the temperature factor indicated in Fig.2.

Note) The normal service temperature of the LM Roller is 80°C at a maximum. If the ambient temperature exceeds 80°C, contact THK.

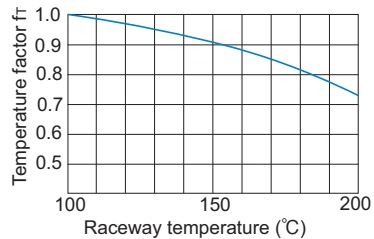

Fig.2 Temperature Factor (f_t)

● f_c : Contact Factor

When multiple LM Roller units are used in near close contact with each other, their linear motion is affected by moments and mounting accuracy, making it difficult to achieve uniform load distribution. In such applications, multiply the basic load rating (C) and (C_0) by the corresponding contact factor in Table2.

Note) If uneven load distribution is expected in a large machine, take into account the respective contact factor indicated in Table2.

Table2 Contact Factor (f_c)

Number of LM Roller units in close contact with each other	Contact factor f_c
2	0.81
3	0.72
4	0.66
5	0.61
Normal use	1

● f_w : Load Factor

In general, reciprocating machines tend to involve vibrations or impact during operation. It is extremely difficult to accurately determine vibrations generated during high-speed operation and impact during frequent start and stop. Therefore, when the actual load applied to the LM Roller cannot be obtained, or when speed and impact have a significant influence, divide the basic load rating (C or C_0) by the corresponding load factor in Table3 of empirically obtained data.

Table3 Load Factor (f_w)

Vibrations/impact	Speed(V)	f_w
Faint	Very low $V \leq 0.25\text{m/s}$	1 to 1.2
Weak	Slow $0.25 < V \leq 1\text{m/s}$	1.2 to 1.5
Medium	Medium $1 < V \leq 2\text{m/s}$	1.5 to 2
Strong	High $V > 2\text{m/s}$	2 to 3.5

Accuracy Standards

When multiple LM Roller units are arranged on the same plane, the mounting heights of the LM Roller units must be identical in order to achieve uniform load distribution. The dimensional tolerance of the LM Roller in height (A) is defined as indicated in Table4. When ordering LM Roller units to be used on the same plane, specify their tolerances with the same classification symbol.

Each classification symbol is marked on the package box and on the side face of the LM Roller's raceway base as indicated in Fig.4. (except for normal grade)

Table4 Classification of Dimensional Tolerances in Height (A)
Unit: μm

Accuracy Grades	Dimensional tolerance for A	Classification symbol
Normal grade	0 to -10	No Symbol
High grade	0 to -5	H5
	-5 to -10	H10
Precision grade	0 to -3	P3
	-3 to -6	P6
	-6 to -9	P9
	-9 to -12	P12
Ultra-precision grade	0 to -2	SP2
	-2 to -4	SP4
	-4 to -6	SP6
	-6 to -8	SP8
	-8 to -10	SP10

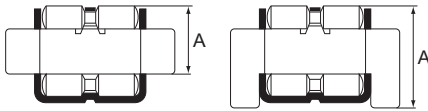
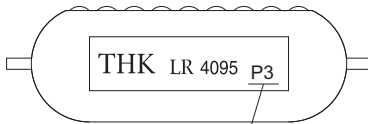

Fig.3 Mounting Height (A) of the LM Roller



Classification symbol for height tolerance

Fig.4

Models LR and LR-Z

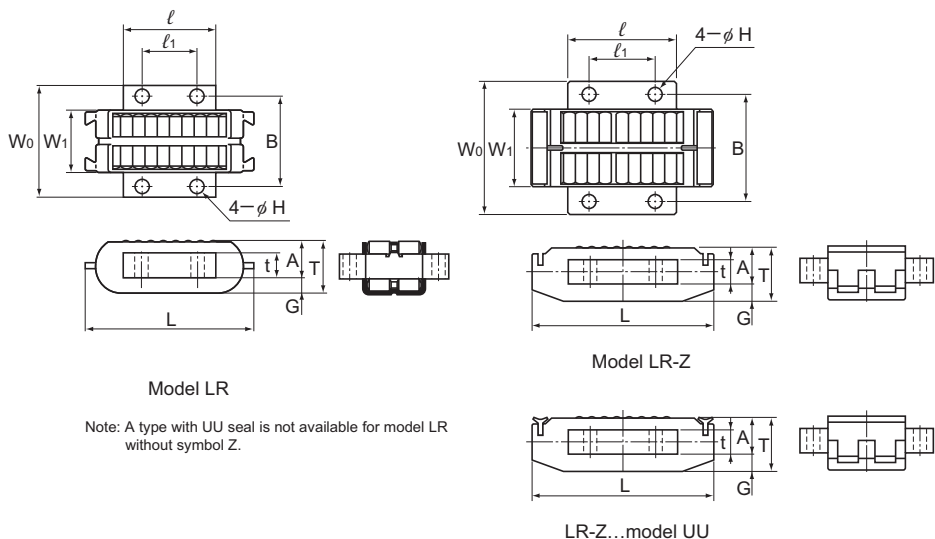

Note: A type with UU seal is not available for model LR without symbol Z.

Unit: mm

Model No.	Main dimensions													Mass g	Basic dynamic load rating C kN	Basic static load rating C ₀ kN
	W ₁	Length	Thickness	Width				ℓ	Mounting hole pitch			Mounting bolt				
	$\begin{matrix} 0 \\ -0.1 \end{matrix}$	L	T	W ₀	A	t	G	$\begin{matrix} 0 \\ -0.2 \end{matrix}$	ℓ ₁	B	H	S				
LR 1547Z	15	47	16	30	11	7	5	20	12	23	3.4	0.2	M3*	60	21.6	39.9
LR 2055Z	20	55	17.3	36	12	8	5.3	30	18	29	4.5	0.2	M4*	110	38.9	84.9
LR 2565Z	25	65	20.6	45	14	9	6.6	35	20	36	5.5	0.1	M5*	190	55	113
LR 3275Z	32	75	21.6	55	15	10	6.6	45	27	44	5.5	0.1	M5*	320	88	208
LR 4095	40	95	30	68	21	14	9	55	35	54	6.6	0.3	M6	800	150	326
LR 50130	50	130	42	82	30	20	12	78	50	66	9	0.3	M8	1810	285	577

Note) Using a hexagonal-socket-head type bolt as the mounting bolt marked with * may cause interference.

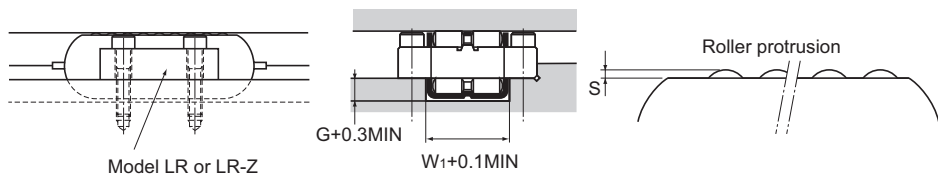

Models LRA and LRA-Z

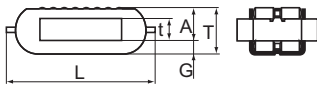
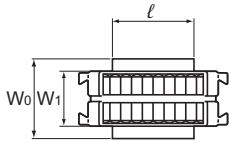

Model LRA

Note: A type with UU seal is not available for model LRA without symbol Z.

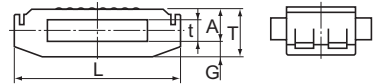
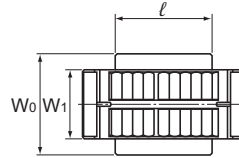

Model LRA-Z

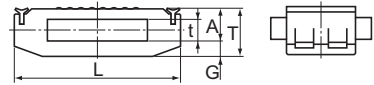

LRA-Z...model UU

Unit: mm

Model No.	Main dimensions									Mass g	Basic dynamic load rating C kN	Basic static load rating C ₀ kN
	W ₁ 0 -0.1	Length L	Thickness T	Width W ₀	A	t	G	ℓ 0 -0.2	S			
LRA 1547Z	15	47	16	22.2	11	7	5	20	0.2	54	21.6	39.9
LRA 2055Z	20	55	17.3	30	12	8	5.3	30	0.2	104	38.9	84.9
LRA 2565Z	25	65	20.6	38.1	14	9	6.6	35	0.1	180	55	113
LRA 3275Z	32	75	21.6	45	15	10	6.6	45	0.1	310	88	208
LRA 4095	40	95	30	55	21	14	9	55	0.3	740	150	326
LRA 50130	50	130	42	76.2	30	20	12	78	0.3	1770	285	577

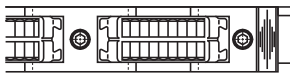

Model LRA or LRA-Z

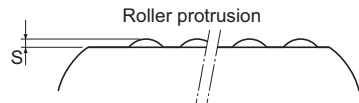
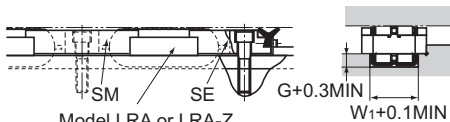

Models LRB and LRB-Z

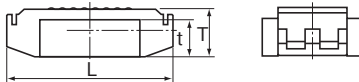
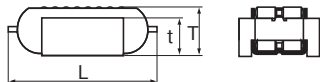
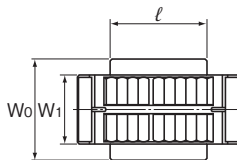
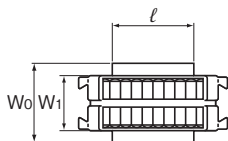

Model LRB

Model LRB-Z

Note: A type with UU seal is not available for model LRB without symbol Z.

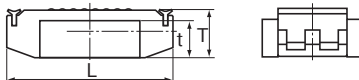

LRB-Z...model UU

Unit: mm

Model No.	Main dimensions							Mass g	Basic dynamic load rating C kN	Basic static load rating C ₀ kN
	W ₁ 0 -0.1	Length L	Width W ₀	Thickness T	t	ℓ 0 -0.2	S			
LRB 1547Z	15	47	22.2	17	13	20	0.2	60	21.6	39.9
LRB 2055Z	20	55	30	18	14	30	0.2	117	38.9	84.9
LRB 2565Z	25	65	38.1	21	16	35	0.1	205	55	113
LRB 3275Z	32	75	45	22	17	45	0.1	340	88	208
LRB 4095	40	95	55	31	24	55	0.3	800	150	326
LRB 50130	50	130	76.2	43	33	78	0.3	1970	285	577

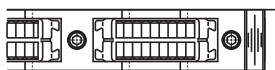

SMB
SEB
Model LRB or LRB-Z

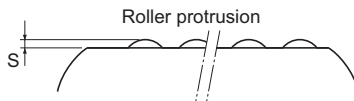

Model LRU

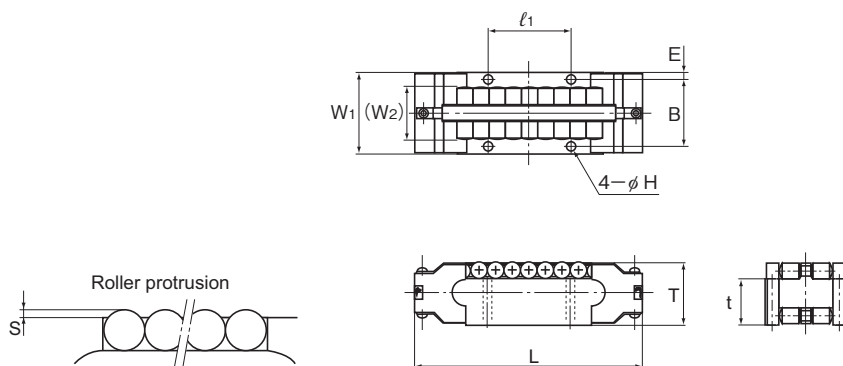

Unit: mm

Model No.	Main dimensions											Mass kg	Basic dynamic load rating C kN	Basic static load rating C ₀ kN
	Thick- ness T mm(inch)	Width		W ₂	t	Length		B	H	S	E			
		W ₁ mm(inch)	Toler- ance			L mm(inch)	l ₁ mm(inch)							
LRU 22.2	14.283 (⁹ / ₁₆)	22.23 (⁷ / ₈)	0 -0.050	11.4	10.48	51 (2)	19.05 (³ / ₄)	17.07	3	0.253	2.58	0.09	22.1	42.5
LRU 25.4	19.05 (³ / ₄)	25.4 (1)	0 -0.050	15.4	13.97	73 (2 ⁷ / ₈)	25.4 (1)	20.6	3.4	0.2	2.40	0.22	41.9	78.9
LRU 38.1	28.573 (1 ¹ / ₈)	38.1 (1 ¹ / ₂)	0 -0.050	23.5	20.953	101.6 (4)	38.1 (1 ¹ / ₂)	30.96	4.5	0.22	3.57	0.7	107	198
LRU 50.8	38.098 (1 ¹ / ₂)	50.8 (2)	0 -0.075	31.5	27.938	139.7 (5 ¹ / ₂)	50.8 (2)	41.28	5.6	0.46	4.76	1.7	171	296
LRU 76.2	57.15 (2 ¹ / ₄)	76.2 (3)	0 -0.075	49.8	41.15	206.4 (8 ¹ / ₈)	76.2 (3)	61.9	6.6	0.5	7.15	5.7	478	807

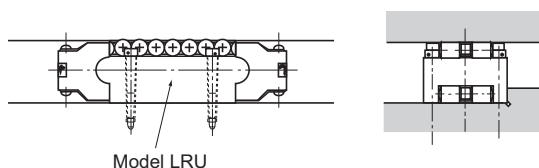
Note) For recommended mounting bolts, see **A10-15**

Model LRU

Raceway

To maximize the performance of the LM Roller, it is necessary to take into account the hardness, surface roughness and accuracy of the raceway, on which the rollers directly roll, when manufacturing the product. In particular, the hardness significantly affects the service life. Therefore, it is important to take much care in selecting a material and heat treatment method.

[Hardness]

We recommend surface hardness of 58 HRC (\cong 653 HV) or higher. The depth of the hardened layer is determined by the size of the LM Roller; we recommend approximately 2 mm for general use. If the hardness of the raceway is lower or the raceway cannot be hardened, multiply the load rating by the corresponding hardness factor (see Fig.1 on **A10-7**).

[Material]

The following materials are generally used as suitable for surface hardening through induction-hardening and flame quenching.

- SUJ2 (JIS G 4805: high-carbon chromium bearing steel)
- SK3 to 6 (JIS G 4401: carbon tool steel)
- S55C (JIS G 4051: carbon steel for machine structural use)

If the machine body is a mold, depending on the conditions, a hardened steel plate may not be used and instead, the surface of mold itself may be hardened.

[Surface Roughness]

To achieve smooth motion, the surface should preferably be finished to Ra0.40 or less. If slight wear is allowed in the initial stage, the surface may be finished to approximately Ra0.80.

[Accuracy]

When high accuracy is required, securing a hardened steel plate to the machine body may cause undulation on the raceway. To avoid this, secure the LM Roller with bolts before grinding the hardened steel plate as with when mounting the product, or tightening it to the machine body before grinding and finishing the raceway, to produce a good result.

Installing the LM Roller

The following are examples of how to install different models of the LM Roller. To minimize the gradient of the LM Roller in the traveling direction, provide a reference surface on the mounting surface and press the LM Roller toward it. The mounting reference surface of the LM Roller is opposite of the THK logo marked on the raceway base.

(a) Installing models LR and LR-Z

Use the four mounting bolt holes on the raceway base to mount the LM Roller.

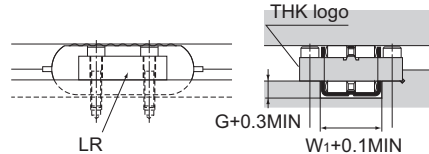

For G and W₁, see the specification table.

(b) Installing models LRA and LRA-Z

The LM Roller can easily be secured using fixture model SM or SE. SE is provided with a wiper to increase contamination protection effect.

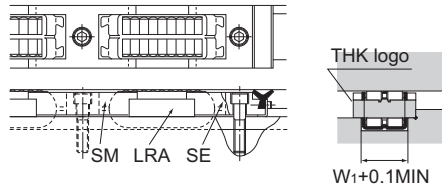

For W₁, see the specification table.

(c) Installing models LRB and LRB-Z

The LM Roller can easily be secured using fixture model SMB or SEB. SEB is provided with a wiper to increase contamination protection effect.

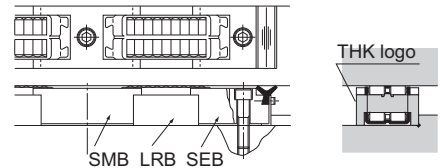

(d) Installing model LRU

Use the four mounting bolt holes built on the raceway base to mount the LM Roller. For the tolerance of the mounting hole, see the figure on the right.

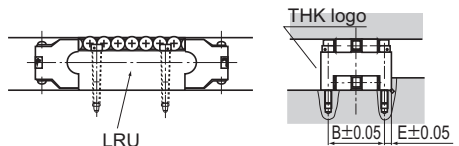

For B and E, see the dimensional table.

For securing model LRU, we recommend the screws shown in Table1.

Table1 Mounting screws for model LRU

Model No.	Hexagonal-Socket-Head Type Bolts	
	Metric screw thread	Inch screw thread
LRU22.2	M2.6	—
LRU25.4	— _{Note)}	4 UNC
LRU38.1	— _{Note)}	8 UNC
LRU50.8	M5	10 UNC
LRU76.2	M6	1/4 UNC

Note) Do not use a metric bolt. The bolt head will interfere with the roller.

Guidance for Adjusting the Clearance

To secure stable accuracy during operation, the LM Roller is provided with a light preload. Provision of a preload is especially effective also in increasing the service life for applications where a vibration impact load or overhang load is applied.

Fig.1 shows clearance adjusting methods that are commonly practiced.

Normally, it is preferable to provide a preload that is approximately 3% of the basic dynamic load rating (C). Providing a preload to the LM Roller will stabilize the accuracy.

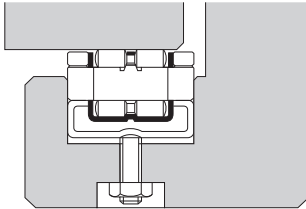

(a) Using a dedicated stopper

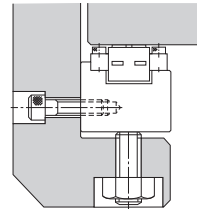

(b) Using a set screw

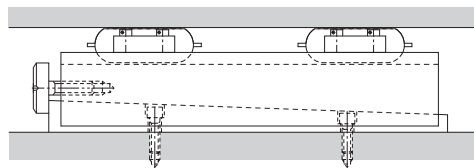
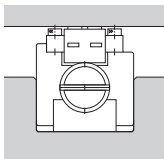

(c) Adjusting a tapered gib

Fig.1 Methods for Adjusting the Clearance of the LM Roller

Examples of Arranging LM Roller Units

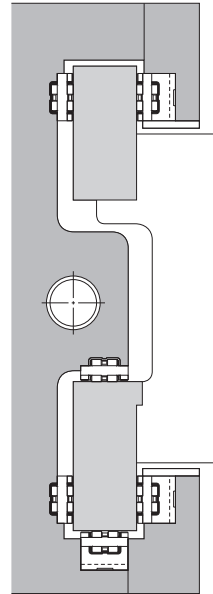
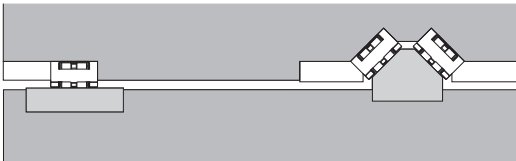
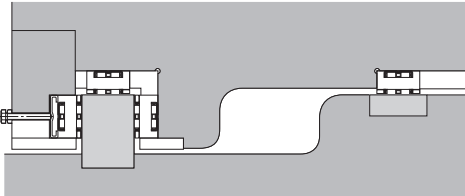
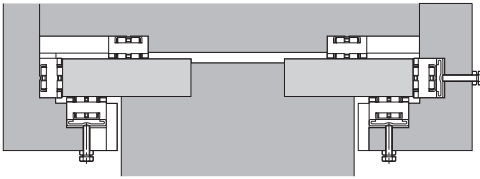
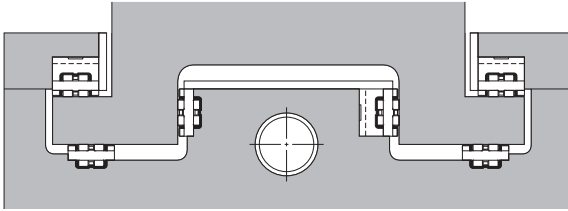

LM Roller

Examples of Installing the LM Roller

Assembling the slide section

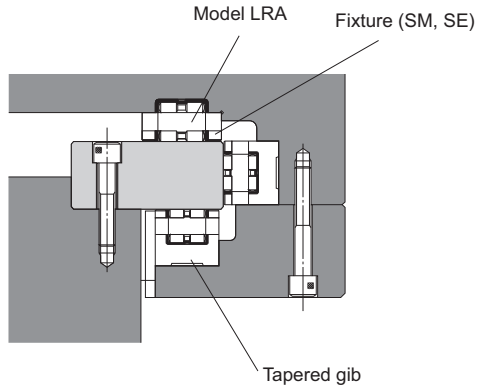

Using the cross rail of a vertical lathe

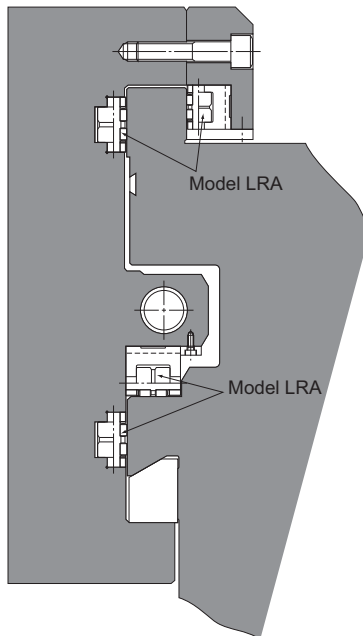

Spring Pad Model PA

● For detailed dimensions, see **A10-21**.

Item name	Schematic diagram / mounting location	Purpose/location of use
Spring Pad Model PA		<p>By attaching this spring pad to the back of the LM Roller as shown in Fig.1 (a) on A10-16 . Turning the adjustment bolt, adjustment of a clearance and a preload can easily be done.</p>

[Guidance for Using the Spring Pad]

Spring pad model PA is a low price item that enables easy adjustment and achieves self-aligning. A preload can easily be adjusted by installing the spring pad to the machine and externally tightening the adjustment bolt using a torque wrench. As a result, the need for troublesome shim adjustment and machining for matching is eliminated.

● Example of Using the Spring Pad

- (1) When using the spring pad in the opposite position to provide a preload

To prevent the table from lifting or guiding it horizontally, using the spring pad on one side as shown in Fig.1 will easily provide a preload and eliminate vibrations and play of the machine.

- (2) When applying both sliding and rolling on the same plane

When desiring to increase friction resistance because the table inertia is large, or desiring to increase rigidity under a heavy load, the spring pad can be used in combination with the sliding surface. To do so, install the LM Roller and the spring pad to several locations on the table as shown in Fig.2, and then tighten the adjustment bolt by the load to be allocated to the LM Roller.

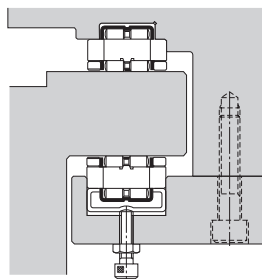

Fig.1

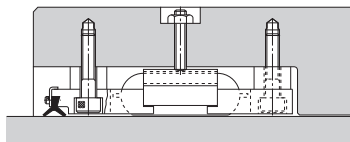

Fig.2

● Guidance for Installing the Spring Pad

Fig.3 shows examples of installing the spring pad model PA to the bottom of the LM Roller and adjusting the clearance and providing a preload.

The dimensions in this example are indicated in the specification table for the spring pad model PA.

The following is the procedure for the installation.

- (1) Secure the fixture and the spacer. Adjust them so that the LM Roller can move vertically.
 - (2) Turn the adjustment bolt until the LM Roller hits the raceway.
 - (3) Turn the adjustment bolt using a torque wrench and tighten it until the desired torque is reached.
- A preload is provided via the spring pad model PA.

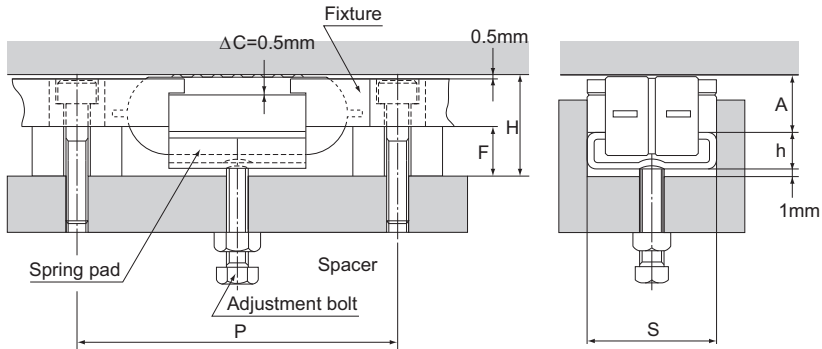
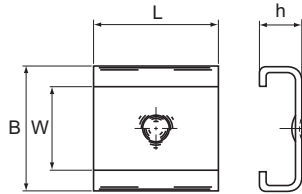

Fig.3

Options

Spring Pad Model PA



Unit: mm

Model No.	Main dimensions				Installation related dimensions (see A10-20)					Maximum permissible load kN	Spring constant kN/mm	Supported LM Roller
	W	B	L	h	H	S +0.15 +0.05	F	P	Adjustment bolt			
PA 15	15	22.2	20	9	21	22.2	11.5	65	M5	1.02	5.4	LRA 1547Z
PA 20	20	30	30	9.5	22.5	30	12	75	M6	2.74	7.5	LRA 2055Z
PA 25	25	38.1	35	12	27	38.1	14.5	90	M8	4.11	9.1	LRA 2565Z
PA 32	32	45	45	12.5	28.5	45	15	100	M8	4.11	11.2	LRA 3275Z
PA 40	40	55	55	16	38	55	18.5	126	M10	4.8	15.3	LRA 4095
PA 50	50	76.2	78	21	52	76.2	23.5	170	M12	6.86	15.5	LRA 50130

LM Roller (Options)

Fixture Models SM/SMB and SE/SEB

● For detailed dimensions, see **A10-23**.

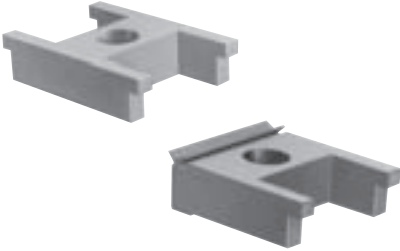
Item name	Schematic diagram / mounting location	Purpose/location of use
Fixture Models SM/SMB and SE/SEB		<p>Use of fixture model SM or SE eliminates the need to machine thin tapped holes for mounting the LM Roller, and allows the roller to firmly be secured. Models SE and SEB each have a special rubber wiper with double lips to achieve a high contamination protection effect.</p>

Fixtures Models SM/SMB

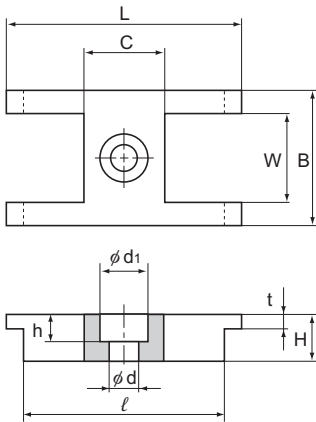

Model SM

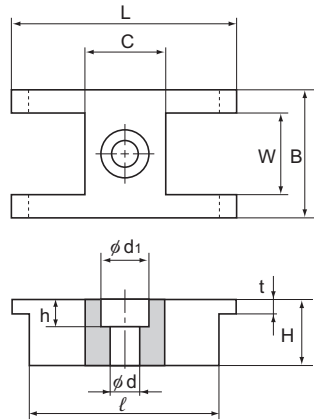

Model SMB

Unit: mm

Model No.	Main dimensions										Mass g
	W	B	L	C	ℓ	H	t	d	d_1	h	
SM 15	15	22.2	53	16	45	9	3	5.5	9.5	5.4	38
SMB 15	15	22.2	53	16	45	15	3	5.5	9.5	5.4	60
SM 20	20.2	30	53	18	45	10	3	6.6	11	6.5	60
SMB 20	20.2	30	53	18	45	16	3	6.6	11	6.5	95
SM 25	25.5	38.1	65	23	55	12	4	9	14	8.6	115
SMB 25	25.5	38.1	65	23	55	19	4	9	14	8.6	120
SM 32	32.5	45	65	23	55	13	4	9	14	8.6	135
SMB 32	32.5	45	65	23	55	20	4	9	14	8.6	215
SM 40	40.5	55	81	28	71	19	6	11	17.5	10.8	290
SMB 40	40.5	55	81	28	71	29	6	11	17.5	10.8	455
SM 50	50.5	76.2	102	38	92	28	9	14	20	13	890
SMB 50	50.5	76.2	102	38	92	41	9	14	20	13	1320

Fixtures Models SE/SEB

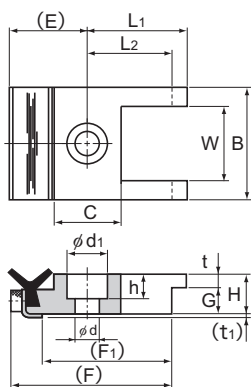

Model SE

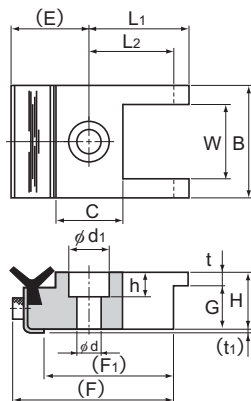

Model SEB

Unit: mm

Model No.	Main dimensions															Mass g
	W	B	L_1	L_2	E	F	F_1	C	H	G	t	t_1	d	d_1	h	
SE 15	15	22.2	26.5	22.5	19	40.5	32.5	16	9	6	3	1	5.5	9.5	5.4	35
SEB 15	15	22.2	26.5	22.5	19	40.5	32.5	16	15	12	3	1	5.5	9.5	5.4	64
SE 20	20.2	30	26.5	22.5	20	41.5	32.5	18	10	7	3	1	6.6	11	6.5	60
SEB 20	20.2	30	26.5	22.5	20	41.5	32.5	18	16	13	3	1	6.6	11	6.5	105
SE 25	25.5	38.1	32.5	27.5	23	49	39	23	12	8	4	1	9	14	8.6	110
SEB 25	25.5	38.1	32.5	27.5	23	49	39	23	19	15	4	1	9	14	8.6	175
SE 32	32.5	45	32.5	27.5	23	49	38	23	13	9	4	1	9	14	8.6	140
SEB 32	32.5	45	32.5	27.5	23	49	38	23	20	16	4	1	9	14	8.6	220
SE 40	40.5	55	40.5	35.5	25	60.5	47.5	28	19	13	6	1	11	17.5	10.8	295
SEB 40	40.5	55	40.5	35.5	25	60.5	47.5	28	29	23	6	1	11	17.5	10.8	415
SE 50	50.5	76.2	51	46	30	76	63	38	28	19	9	1	14	20	13	840
SEB 50	50.5	76.2	51	46	30	76	63	38	41	32	9	1	14	20	13	1245

Model Number Coding

Model number configurations differ depending on the model features. Refer to the corresponding sample model number configuration.

[LM Roller]

● Models LR-Z, LRA-Z and LRB-Z

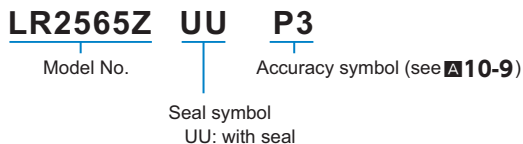

● Models LR, LRA, LRB and LRU

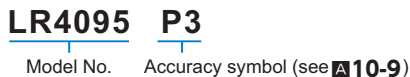

Note) Types with UU seal are not available for LR, LRA, LRB and LRU without symbol Z.

[Options]

● Models PA, SM, SMB, SE and SEB



Notes on Ordering

When multiple LM Roller units are arranged in the same plane, the mounting heights of the LM Roller units must be identical in order to achieve uniform load distribution. See **A10-9** for details.

Precautions on Use

LM Roller

[Handling]

- (1) Do not disassemble the parts. This will result in loss of functionality.
- (2) Take care not to drop or strike the LM Roller. Doing so may cause injury or damage. Giving an impact to it could also cause damage to its function even if the product looks intact.
- (3) When handling the product, wear protective gloves, safety shoes, etc., as necessary to ensure safety.

[Precautions on Use]

- (1) Prevent foreign material, such as cutting chips or coolant, from entering the product. Failure to do so may cause damage.
- (2) If the product is used in an environment where cutting chips, coolant, corrosive solvents, water, etc., may enter the product, use bellows, covers, etc., to prevent them from entering the product.
- (3) If foreign material such as cutting chips adheres to the product, replenish the lubricant after cleaning the product.
- (4) Do not use the product at temperature of 80°C or higher.
- (5) Do not use undue force when fitting parts (pin, key, etc.) to the product. This may generate permanent deformation on the raceway, leading to loss of functionality.

[Dust-proofing and Lubrication]

- (1) Foreign matter that gets inside the LM Roller due to inadequate dust-proofing is very difficult to remove and is apt to cause damage to the raceway and the LM Roller. Please take extra care to ensure that the unit is protected from dust and other contaminants.
- (2) The model SE and SEB Fixtures for the LM Roller are equipped with a special rubber wiper that helps provide effective protection against dust and other contaminants. When attaching either Fixture, apply grease between the double lips, as shown in Fig.1, for additional protection.
- (3) If the unit is in a location exposed to cutting chips or welding spatter, it must be protected with an accordion-type or telescoping dust cover or the like, or equipped with a wiper reinforced with a metal plate, as shown in Fig.2.

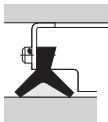

Fig.1 Wiper on model SE and SEB Fixtures

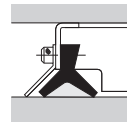

Fig.2 Reinforced wiper

- (4) Two strategies for laterally oriented protection against contaminants are illustrated in Fig.3.

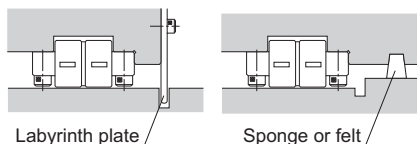

Fig.3

Precautions on Use

- (5) This unit needs much less lubricant than a sliding guide, making lubrication easier to manage.
The same type of grease or lubricant used on ordinary bearings will suffice, but for optimal lubricant retention the best options are lithium grease no. 1 or 2, or a moderately viscous oil designed for sliding surfaces, or turbine oil.
When necessary, lubricate the LM Roller by adding drops of lubricant through the oil hole on the back of the retainer, or dribble or smear lubricant directly on the raceway. If the LM Roller is used only infrequently, grease can be smeared directly on the roller.
- (6) Do not mix different lubricants. Mixing greases using the same type of thickening agent may still cause adverse interaction between the two greases if they use different additives, etc.
- (7) Micro-strokes tend to obstruct oil film to form on the raceway in contact with the rolling element, and may lead to fretting corrosion. Take consideration using grease offering excellent fretting prevention. It is also recommended that a stroke movement corresponding to the length of the LM Roller be made on a regular basis to make sure oil film is formed between the raceway and rolling element.
- (8) When using the product in locations exposed to constant vibrations or in special environments such as clean rooms, vacuum and low/high temperature, use the grease appropriate for the specification/environment.
- (9) The consistency of grease changes according to the temperature. Take note that the slide resistance of the LM Roller also changes as the consistency of grease changes.
- (10) After lubrication, the slide resistance of the LM Roller may increase due to the agitation resistance of grease. Be sure to perform a break-in to let the grease spread fully, before operating the machine.
- (11) Excess grease may scatter immediately after lubrication, so wipe off scattered grease as necessary.
- (12) The properties of grease deteriorate and its lubrication performance drops over time, so grease must be checked and added properly according to the use frequency of the machine.
- (13) The greasing interval varies depending on the use condition and service environment. Set the final lubrication interval/amount based on the actual machine.

[Mounting Reference Surface]

To help correctly mount the LM Roller in the traveling direction, it has a mounting reference surface on the side face of the raceway base. The reference surface is on the opposite side of the THK logo.

[Mounting Precision]

To maximize the performance of the LM Roller, it is necessary to distribute the load as evenly as possible when mounting the product. Fig.4 For the parallelism between the roller and the raceway indicated in , we recommend 0.015 mm or less against 100 mm. For the allowable tilt of the roller in the longitudinal direction, 0.01 mm or less against 100 mm is recommended.



(a) Parallelism between the LM Roller and the raceway (b) Allowable tilt of the roller in the longitudinal direction

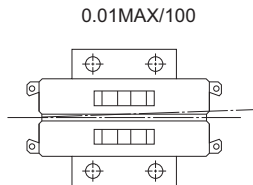

(c) Parallelism between the LM Roller and the raceway in the horizontal direction

Fig.4 LM Roller and Mounting Precision

[Storage]

When storing the LM Roller, enclose it in a package designated by THK and store it in a room in a horizontal orientation while avoiding high temperature, low temperature and high humidity.

[Disposal]

Dispose of the product properly as industrial waste.



LM Roller

THK General Catalog

B Support Book

Features and Types	A10-2
Features of the LM Roller	A10-2
• Structure and Features	A10-2
Types of the LM Roller	A10-4
• Types and Features	A10-4
Point of Selection	A10-6
Nominal Life	A10-6
Mounting Procedure	A10-9
Installing the LM Roller	A10-9
Examples of Installing the LM Roller..	A10-10
Model No.	A10-11
• Model Number Coding	A10-11
• Notes on Ordering	A10-11
Precautions on Use	A10-12

A Product Descriptions (Separate)

Features and Types	A10-2
Features of the LM Roller	A10-2
• Structure and Features	A10-2
Types of the LM Roller	A10-4
• Types and Features	A10-4
Point of Selection	A10-6
Nominal Life	A10-6
Accuracy Standards	A10-9
Dimensional Drawing, Dimensional Table	
Models LR and LR-Z	A10-10
Models LRA and LRA-Z	A10-11
Models LRB and LRB-Z	A10-12
Model LRU	A10-13
Point of Design	A10-14
Raceway	A10-14
Installing the LM Roller	A10-15
Guidance for Adjusting the Clearance..	A10-16
Examples of Arranging LM Roller Units..	A10-17
Examples of Installing the LM Roller..	A10-18
Options	A10-19
Spring Pad Model PA	A10-19
Fixture Models SM/SMB and SE/SEB..	A10-22
• Fixtures Models SM/SMB	A10-23
• Fixtures Models SE/SEB	A10-24
Model No.	A10-25
• Model Number Coding	A10-25
• Notes on Ordering	A10-25
Precautions on Use	A10-26

Features of the LM Roller

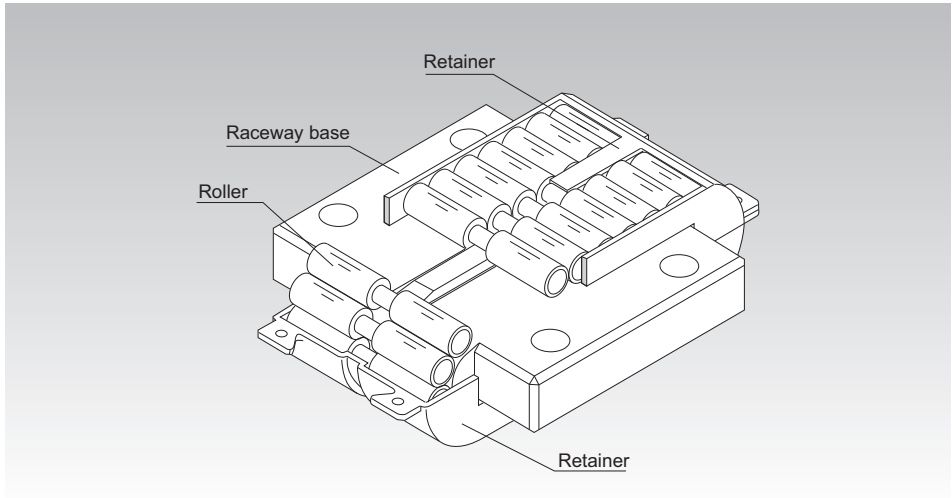

Fig.1 Structure of LM Roller Model LR

Structure and Features

In the LM Roller, dual rollers assembled on the circumference of the precision-ground, rigid raceway base travel in infinite circulation while being held by a retainer. A center guide integrated with the raceway base is formed in the central part of the loaded area of the raceway base to constantly correct skewing of the rollers. This unique structure ensures smooth rolling motion. The LM Roller is used in applications such as the XYZ guide of NC machine tools, precision press ram guides, press dies changers and heavy-load conveyance systems.

Features and Types

Features of the LM Roller

[Supports an Ultra Heavy Load and Ensures Smooth Motion]

The LM Roller is compact and capable of carrying a heavy load, and one unit of model LR50130 (length: 130 mm; width: 82 mm; height: 42 mm) is capable of receiving a 255 kN load. Moreover, because of rolling motion, this model has a low friction coefficient ($\mu = 0.005$ to 0.01) and is free from stick-slip, thus achieving highly accurate straight motion.

[High Combined Accuracy]

In general, when supporting a single plane with LM rollers, multiple units of LM rollers are combined on the same plane, and therefore, the height difference between the rollers significantly affects the machine accuracy and service life. With THK LM Roller, the user can select a combination of models with a height difference of up to $2 \mu\text{m}$.

[Rational Skewing-preventing Structure]

With an LM system using rollers, once the rollers skew, it increases friction resistance or decreases running accuracy.

To prevent skewing, the LM Roller has roller guides on the center of the retainer full circle, and in the center of the loaded area on the raceway base. This structure enables the LM Roller to automatically correct skewing caused by a mounting accuracy error and the rollers to travel in an orderly manner. It also allows the LM Roller to be installed with slant mount or wall mount while demonstrating high performance.

Types of the LM Roller

Types and Features

Model LR

This model is designed to be fit into a groove machined on the mounting surface. By screwing bolts into four holes on the raceway base, it is secured on the mounting surface. (Fixture models SM and SE are also available.)

Specification Table⇒ [A10-10](#)

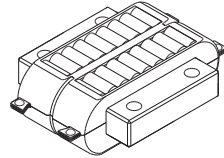

Model LR

Model LR-Z

A lighter type that uses a resin retainer and is designed to be mounted in the same manner as model LR. Since it has a groove for installing a seal, a special rubber seal with a high contamination protection effect can easily be attached. In addition, this model is capable of high-speed traveling at 1 m/s.

Specification Table⇒ [A10-10](#)

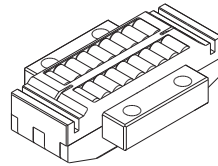

Model LR-Z

Model LRA

Just like model LR, this model is also designed to be fit into a groove. It is a compact type that can be mounted using fixture model SM or SE and bolts.

Specification Table⇒ [A10-11](#)

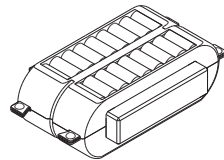

Model LRA

Model LRA-Z

A lighter type that uses a resin retainer and is designed to be mounted in the same manner as model LRA. Since it has a groove for installing a seal, a special rubber seal with a high contamination protection effect can easily be attached. In addition, this model is capable of high-speed traveling at 1 m/s.

Specification Table⇒ [A10-11](#)

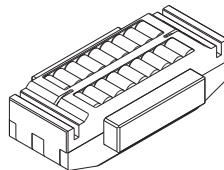

Model LRA-Z

Model LRB

Since this model does not require a groove on the mounting surface, man-hours for machining can be reduced. It can be mounted using fixture model SMB or SE and bolts.

Specification Table⇒ **A**10-12

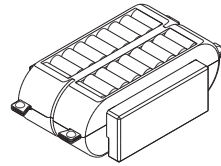

Model LRB

Model LRB-Z

A lighter type that uses a resin retainer and is designed to be mounted in the same manner as model LRB. Since it has a groove for installing a seal, a special rubber seal with a high contamination protection effect can easily be attached. In addition, this model is capable of high-speed traveling at 1 m/s.

Specification Table⇒ **A**10-12

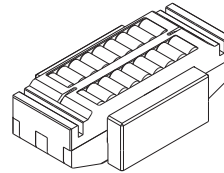

Model LRB-Z

Model LRU

Since this model does not require a groove on the mounting surface, man-hours for machining can be reduced. By screwing bolts into four holes on the raceway base, it is secured on the mounting surface.

Specification Table⇒ **A**10-13

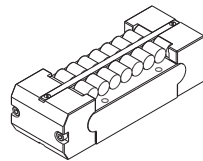

Model LRU

Nominal Life

[Static Safety Factor f_s]

The LM Roller may receive an unexpected external force while it is stationary or operative due to the generation of an inertia caused by vibrations and impact or start and stop. It is necessary to consider a static safety factor against such a working load.

$$f_s = \frac{f_c \cdot C_0}{P_c}$$

f_s : Static safety factor

f_c : Contact factor

(see Table2 on **B10-8**)

C_0 : Basic static load rating (kN)

P_c : Calculated load (kN)

● Reference Value of Static Safety Factor

The static safety factors indicated in Table1 are the lower limits of reference values in the respective conditions.

Table1 Reference Value of Static Safety Factors (f_s)

Machine using the LM system	Load conditions	Lower limit of f_s
General industrial machinery	Without vibration or impact	1 to 1.3
	With vibration or impact	2 to 3
Machine tool	Without vibration or impact	1 to 1.5
	With vibration or impact	2.5 to 7

[Nominal Life]

The nominal life of the LM Roller is obtained using the basic dynamic load rating (C) indicated in the corresponding specification table, and the following equation.

$$L = \left(\frac{f_H \cdot f_C \cdot f_T}{f_W} \cdot \frac{C}{P_C} \right)^{\frac{10}{3}} \times 100$$

- L : Nominal life (km)
 (The total number of revolutions that 90% of a group of identical LM Roller units independently operating under the same conditions can achieve without showing flaking)
- C : Basic dynamic load rating (kN)
- P_C : Calculated radial load (kN)
- f_H : Hardness factor (see Fig.1)
- f_T : Temperature factor
 (see Fig.2 on [B10-8](#))
- f_C : Contact factor
 (see Table2 on [B10-8](#))
- f_W : Load factor (see Table3 on [B10-8](#))

[Calculating the Service Life Time]

When the nominal life (L) has been obtained, if the stroke length and the number of reciprocations per minute are constant, the service life time is obtained using the following equation.

$$L_h = \frac{L \times 10^6}{2 \times l_s \times n_1 \times 60}$$

- L_h : Service life time (h)
- l_s : Stroke length (mm)
- n₁ : Number of reciprocations per minute (min⁻¹)

● f_H: Hardness Factor

To maximize the load capacity of the LM system, the hardness of the raceways needs to be between 58 to 64 HRC. If the hardness is lower than this range, the basic dynamic load rating and the basic static load rating decrease. Therefore, it is necessary to multiply each rating by the respective hardness factor (f_H).

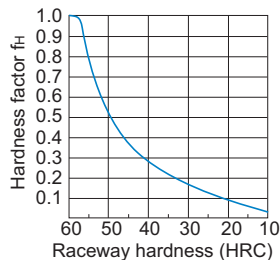

Fig.1 Hardness Factor (f_H)

● f_t : Temperature Factor

If the temperature of the environment surrounding the operating LM Roller exceeds 100°C, take into account the adverse effect of the high temperature and multiply the basic load ratings by the temperature factor indicated in Fig.2.

Note) The normal service temperature of the LM Roller is 80°C at a maximum. If the ambient temperature exceeds 80°C, contact THK.

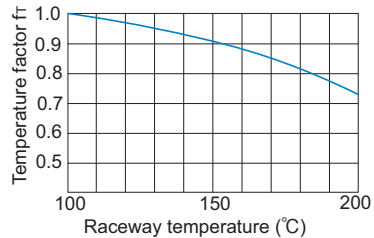

Fig.2 Temperature Factor (f_t)

● f_c : Contact Factor

When multiple LM Roller units are used in near close contact with each other, their linear motion is affected by moments and mounting accuracy, making it difficult to achieve uniform load distribution. In such applications, multiply the basic load rating (C) and (C_0) by the corresponding contact factor in Table2.

Note) If uneven load distribution is expected in a large machine, take into account the respective contact factor indicated in Table2.

Table2 Contact Factor (f_c)

Number of LM Roller units in close contact with each other	Contact factor f_c
2	0.81
3	0.72
4	0.66
5	0.61
Normal use	1

● f_w : Load Factor

In general, reciprocating machines tend to involve vibrations or impact during operation. It is extremely difficult to accurately determine vibrations generated during high-speed operation and impact during frequent start and stop. Therefore, when the actual load applied to the LM Roller cannot be obtained, or when speed and impact have a significant influence, divide the basic load rating (C or C_0) by the corresponding load factor in Table3 of empirically obtained data.

Table3 Load Factor (f_w)

Vibrations/impact	Speed(V)	f_w
Faint	Very low $V \leq 0.25\text{m/s}$	1 to 1.2
Weak	Slow $0.25 < V \leq 1\text{m/s}$	1.2 to 1.5
Medium	Medium $1 < V \leq 2\text{m/s}$	1.5 to 2
Strong	High $V > 2\text{m/s}$	2 to 3.5

Installing the LM Roller

The following are examples of how to install different models of the LM Roller. To minimize the gradient of the LM Roller in the traveling direction, provide a reference surface on the mounting surface and press the LM Roller toward it. The mounting reference surface of the LM Roller is opposite of the THK logo marked on the raceway base.

(a) Installing models LR and LR-Z

Use the four mounting bolt holes on the raceway base to mount the LM Roller.

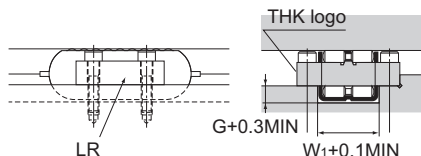

For G and W₁, see the specification table.

(b) Installing models LRA and LRA-Z

The LM Roller can easily be secured using fixture model SM or SE. SE is provided with a wiper to increase contamination protection effect.

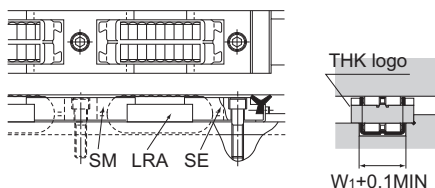

For W₁, see the specification table.

(c) Installing models LRB and LRB-Z

The LM Roller can easily be secured using fixture model SMB or SEB. SEB is provided with a wiper to increase contamination protection effect.

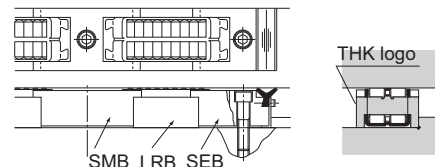

(d) Installing model LRU

Use the four mounting bolt holes built on the raceway base to mount the LM Roller. For the tolerance of the mounting hole, see the figure on the right.

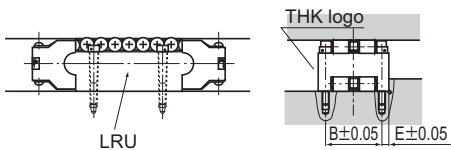

For B and E, see the dimensional table.

For securing model LRU, we recommend the screws shown in Table 1.

Table 1 Mounting screws for model LRU

Model No.	Hexagonal-Socket-Head Type Bolts	
	Metric screw thread	Inch screw thread
LRU22.2	M2.6	—
LRU25.4	— ^{Note)}	4 UNC
LRU38.1	— ^{Note)}	8 UNC
LRU50.8	M5	10 UNC
LRU76.2	M6	1/4 UNC

Note) Do not use a metric bolt. The bolt head will interfere with the roller.

Examples of Installing the LM Roller

Assembling the slide section

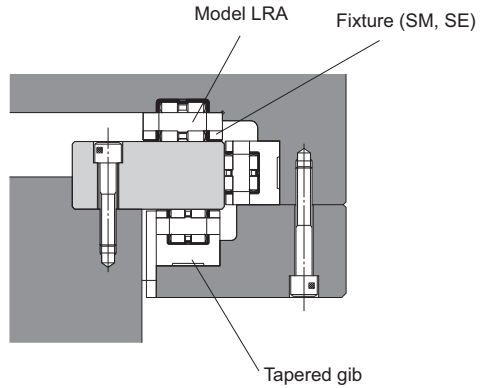

Using the cross rail of a vertical lathe

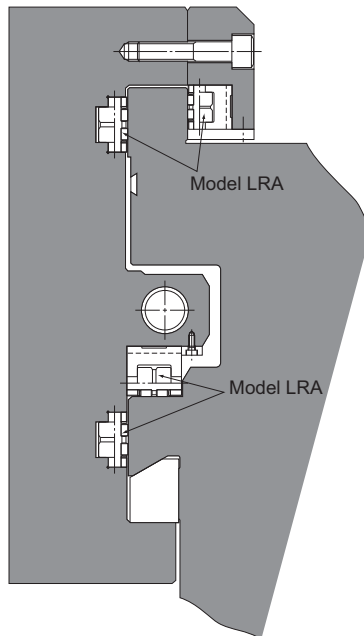

Model Number Coding

Model number configurations differ depending on the model features. Refer to the corresponding sample model number configuration.

[LM Roller]

● Models LR-Z, LRA-Z and LRB-Z

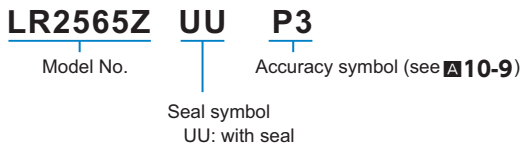

● Models LR, LRA, LRB and LRU

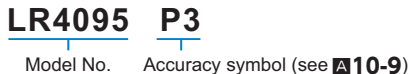

Note) Types with UU seal are not available for LR, LRA, LRB and LRU without symbol Z.

[Options]

● Models PA, SM, SMB, SE and SEB



Notes on Ordering

When multiple LM Roller units are arranged in the same plane, the mounting heights of the LM Roller units must be identical in order to achieve uniform load distribution. See **A10-9** for details.

Precautions on Use

LM Roller

[Handling]

- (1) Do not disassemble the parts. This will result in loss of functionality.
- (2) Take care not to drop or strike the LM Roller. Doing so may cause injury or damage. Giving an impact to it could also cause damage to its function even if the product looks intact.
- (3) When handling the product, wear protective gloves, safety shoes, etc., as necessary to ensure safety.

[Precautions on Use]

- (1) Prevent foreign material, such as cutting chips or coolant, from entering the product. Failure to do so may cause damage.
- (2) If the product is used in an environment where cutting chips, coolant, corrosive solvents, water, etc., may enter the product, use bellows, covers, etc., to prevent them from entering the product.
- (3) If foreign material such as cutting chips adheres to the product, replenish the lubricant after cleaning the product.
- (4) Do not use the product at temperature of 80°C or higher.
- (5) Do not use undue force when fitting parts (pin, key, etc.) to the product. This may generate permanent deformation on the raceway, leading to loss of functionality.

[Dust-proofing and Lubrication]

- (1) Foreign matter that gets inside the LM Roller due to inadequate dust-proofing is very difficult to remove and is apt to cause damage to the raceway and the LM Roller. Please take extra care to ensure that the unit is protected from dust and other contaminants.
- (2) The model SE and SEB Fixtures for the LM Roller are equipped with a special rubber wiper that helps provide effective protection against dust and other contaminants. When attaching either Fixture, apply grease between the double lips, as shown in Fig.1, for additional protection.
- (3) If the unit is in a location exposed to cutting chips or welding spatter, it must be protected with an accordion-type or telescoping dust cover or the like, or equipped with a wiper reinforced with a metal plate, as shown in Fig.2.

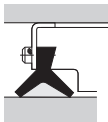

Fig.1 Wiper on model SE and SEB Fixtures

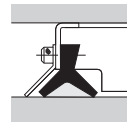

Fig.2 Reinforced wiper

- (4) Two strategies for laterally oriented protection against contaminants are illustrated in Fig.3.

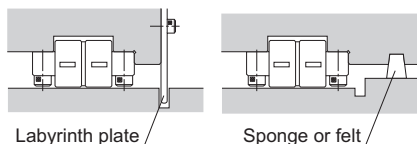

Fig.3

Precautions on Use

- (5) This unit needs much less lubricant than a sliding guide, making lubrication easier to manage. The same type of grease or lubricant used on ordinary bearings will suffice, but for optimal lubricant retention the best options are lithium grease no. 1 or 2, or a moderately viscous oil designed for sliding surfaces, or turbine oil. When necessary, lubricate the LM Roller by adding drops of lubricant through the oil hole on the back of the retainer, or dribble or smear lubricant directly on the raceway. If the LM Roller is used only infrequently, grease can be smeared directly on the roller.
- (6) Do not mix different lubricants. Mixing greases using the same type of thickening agent may still cause adverse interaction between the two greases if they use different additives, etc.
- (7) Micro-strokes tend to obstruct oil film to form on the raceway in contact with the rolling element, and may lead to fretting corrosion. Take consideration using grease offering excellent fretting prevention. It is also recommended that a stroke movement corresponding to the length of the LM Roller be made on a regular basis to make sure oil film is formed between the raceway and rolling element.
- (8) When using the product in locations exposed to constant vibrations or in special environments such as clean rooms, vacuum and low/high temperature, use the grease appropriate for the specification/environment.
- (9) The consistency of grease changes according to the temperature. Take note that the slide resistance of the LM Roller also changes as the consistency of grease changes.
- (10) After lubrication, the slide resistance of the LM Roller may increase due to the agitation resistance of grease. Be sure to perform a break-in to let the grease spread fully, before operating the machine.
- (11) Excess grease may scatter immediately after lubrication, so wipe off scattered grease as necessary.
- (12) The properties of grease deteriorate and its lubrication performance drops over time, so grease must be checked and added properly according to the use frequency of the machine.
- (13) The greasing interval varies depending on the use condition and service environment. Set the final lubrication interval/amount based on the actual machine.

[Mounting Reference Surface]

To help correctly mount the LM Roller in the traveling direction, it has a mounting reference surface on the side face of the raceway base. The reference surface is on the opposite side of the THK logo.

[Mounting Precision]

To maximize the performance of the LM Roller, it is necessary to distribute the load as evenly as possible when mounting the product. Fig.4 For the parallelism between the roller and the raceway indicated in , we recommend 0.015 mm or less against 100 mm. For the allowable tilt of the roller in the longitudinal direction, 0.01 mm or less against 100 mm is recommended.



(a) Parallelism between the LM Roller and the raceway (b) Allowable tilt of the roller in the longitudinal direction

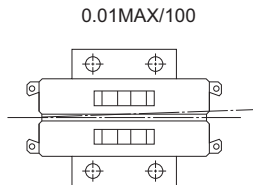

(c) Parallelism between the LM Roller and the raceway in the horizontal direction

Fig.4 LM Roller and Mounting Precision

[Storage]

When storing the LM Roller, enclose it in a package designated by THK and store it in a room in a horizontal orientation while avoiding high temperature, low temperature and high humidity.

[Disposal]

Dispose of the product properly as industrial waste.