

Introduction to

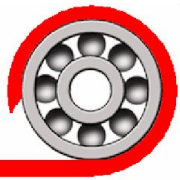

CATERPILLAR

RBC Mining Applications



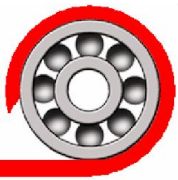

Caterpillar & RBC Bearings

- Spherical Plain Bearings supplier for linkages, suspensions, cylinders and pivot positions.



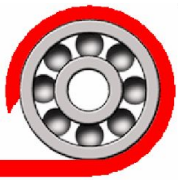

Caterpillar

CAT D9T Equalizer Bar

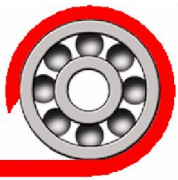

- Connects tracks to center pivot
- Spherical Plain Bearings Subjected to impact radial & axial loads
- Heavy Contamination

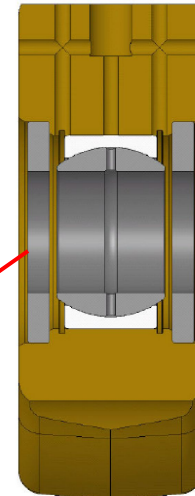
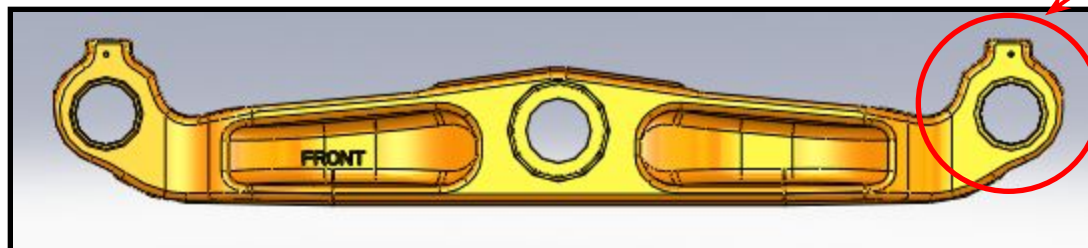

CAT 777 NTI Maintenance Free Program

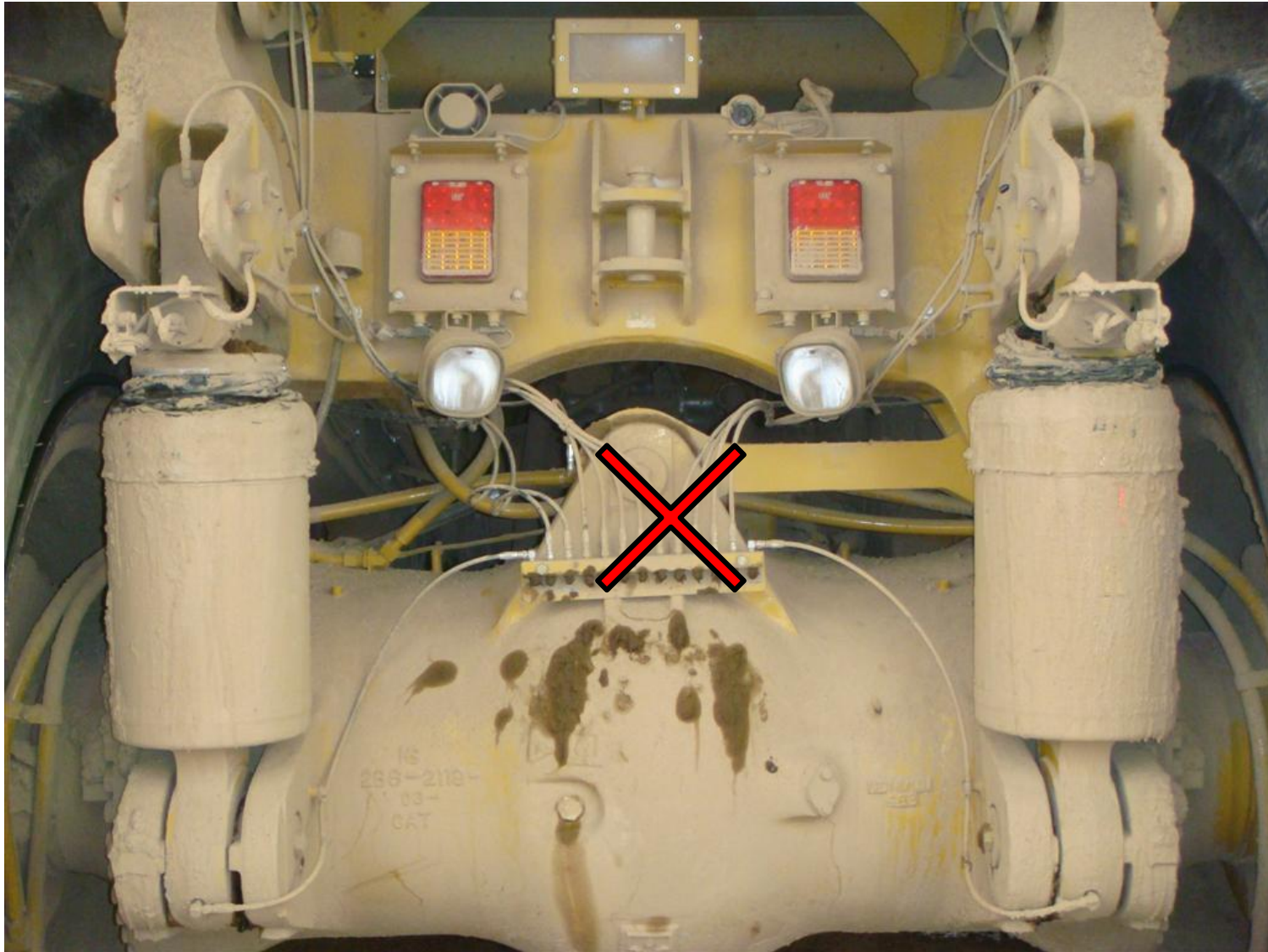
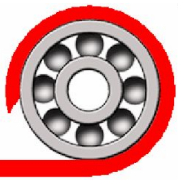

CAT 777 NTI Maintenance Free Program

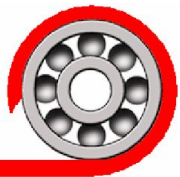

- Determine if Maintenance Free bearing systems are viable (NTI)
- Option or replacement for Auto-Lube
- Trucks operational at TPG, Granite Canyon -Wyoming

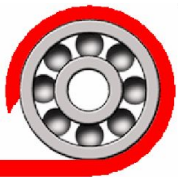

627 Scraper Articulation Joints

- NPI project addresses post-warranty concerns with current bearing system
- 11 positions involved



627 Scraper Articulation Joints

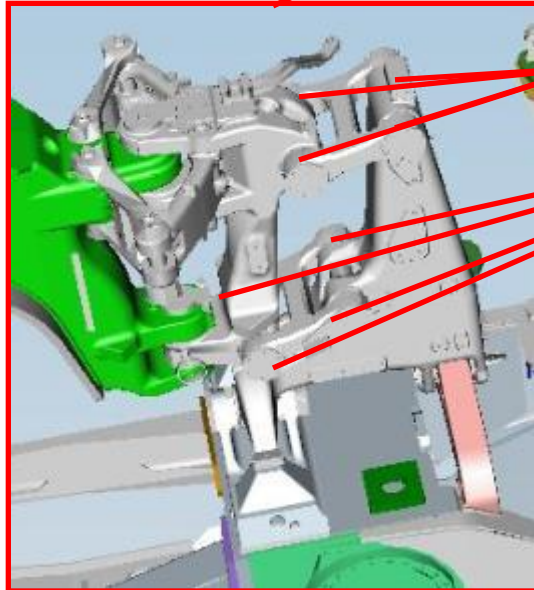
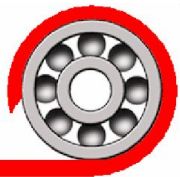

8 pcs Cushion Hitch Bushings

Articulation Joint:
1 Upper radial
1 Lower radial
1 Thrust brg.

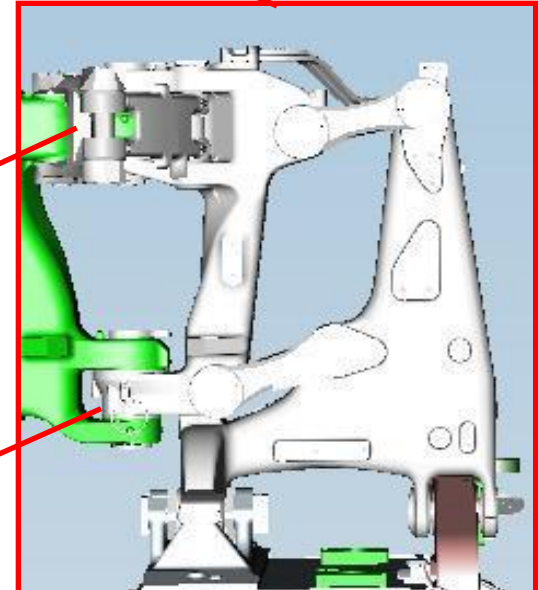

627 Scraper Articulation Joints

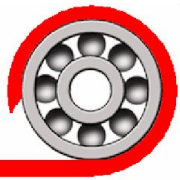

UPPER



LOWER

Cushion HITCH



THRUST



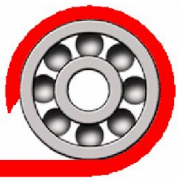

627 Scraper Articulation Joints

- 3 Machines operating in Texas
- 1 machine operating in San Diego
- 1 machine operating at PPG



CAT - Articulated Trucks

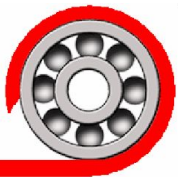

- Articulation Hitch
- A-Frame
- Hoist cylinders
- Suspension Cylinders (front & rear)
- Steering Cylinders
- Panhard Link
- Dump Body Pivot



SCHAUBLIN Bearings



Motorized Land Vehicles
Suspension System Products



RBC SCHAUBLIN – Suspension system products



Engineering Support

We offer a variety of engineering services from the selection of bearing materials to in-house testing of bearing assemblies.

Quality Assurance

SCHAUBLIN is certified to the standards for industrial, railway and aerospace industries

- AQF-2
- ISO9001-2000
- EN9100-2003

Applications

- Suspension pivot joints
- Damper attachments
- Anti roll bar linkages
- Shock absorber joints
- Tilt mechanism and actuation systems
- Independent suspension axle systems
- Wishbone bearings
- Racing cars, rally cars
- All Terrain Vehicles
- Military vehicles



Independent Suspension



- Independent Suspension Axle System
- Ideally suited for severe duty commercial and military vocational applications

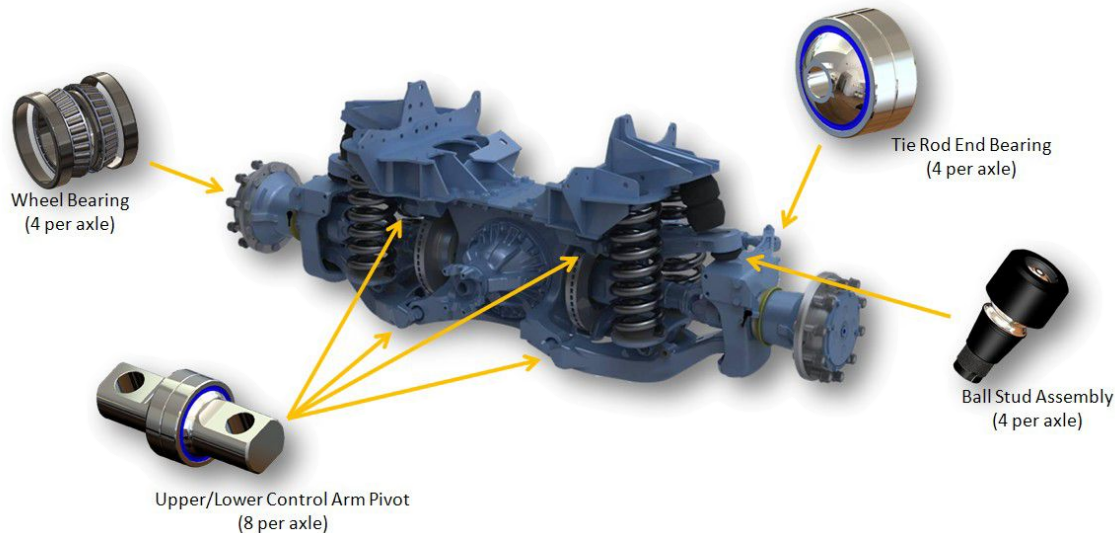

MRAP Vehicles (Mine Resistant Ambush Protected)



- MaxxPro® Dash
- Enhanced Independent suspension with DXM™
- RBC Bearings featuring the new AxleTech/Hendrickson DXM™ independent suspension axle system

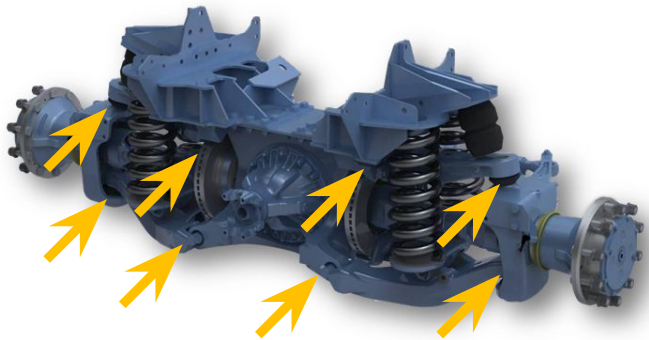

SCHAUBLIN

MTV Medium Tactical Vehicles



- High mobility MTV 7000-MV platform
- Incorporates the DXM™ independent suspension
- RBC Bearings featuring the new AxleTech/Hendrickson DXM™ independent suspension axle system

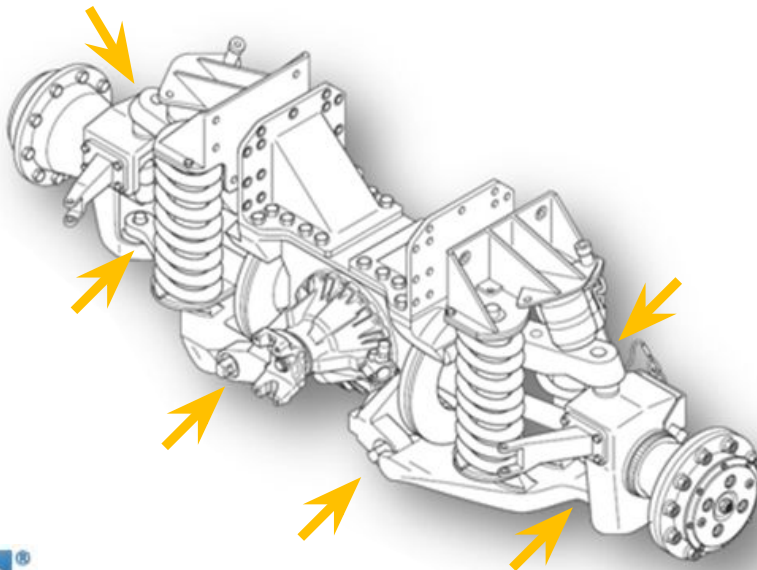

Other Military vehicles equipped with independent suspension systems



- M-ATV (MRAP All Terrain Vehicle)
- High Mobility Multipurpose Wheeled Vehicle (HMMWV)

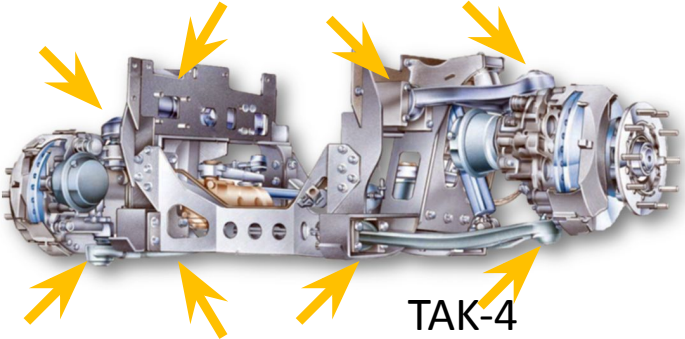

TAK-4 suspension system



Other Military vehicles equipped with independent suspension systems



- MTRV (Medium Tactical Vehicle Replacement)
- FMTV (Family of Medium Tactical Vehicles)

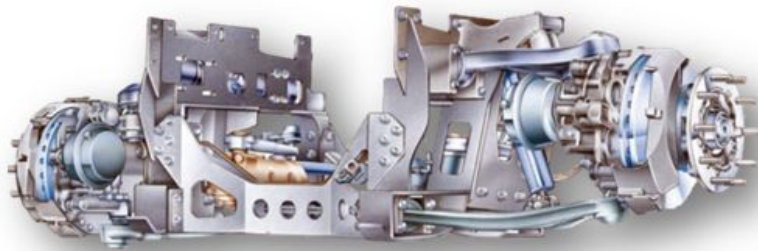

TAK-4
suspension system



RBC SCHAUBLIN – Shock bearings



- Our bearings are designed to work in severe environments
 - Resistant to contamination
 - Sealed with integral boots
 - Rigid
 - Shock and fatigue resistant
 - Wear resistant

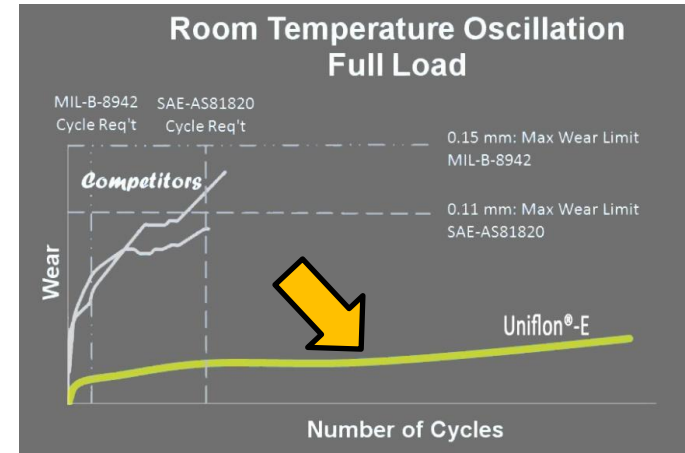
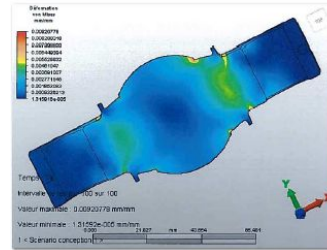
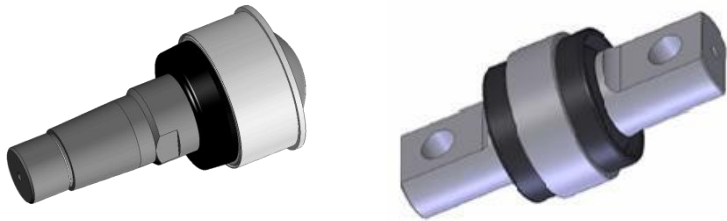

Other land vehicles equipped with independent suspension systems



- Aircraft rescue and firefighting (ARFF) trucks
- Firefighting vehicles



SCHAUBLIN

Merkava-An alternative to rotary shocks and torsion bars



M113 Track Personnel Carrier

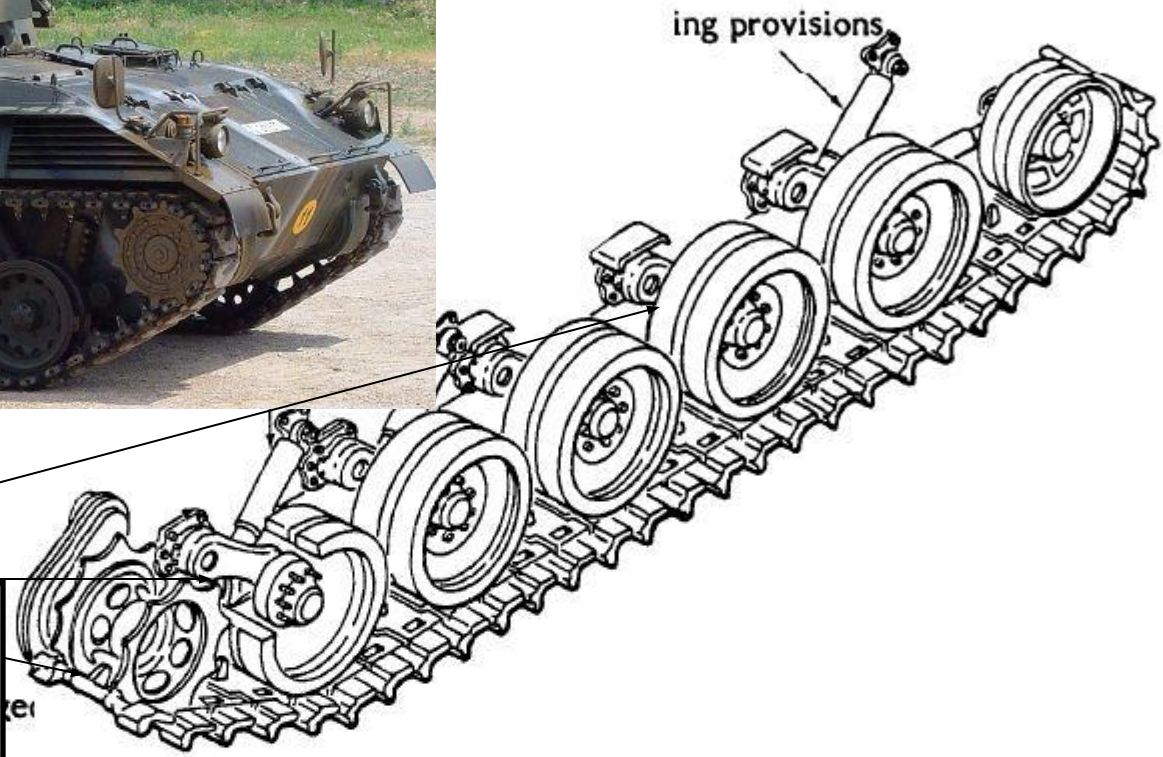

Spherical Bearing
In Shock



Heim LHSM14A



Hinges Have Bearings



http://en.wikipedia.org/wiki/Image:EFV_hydroplaning.jpg

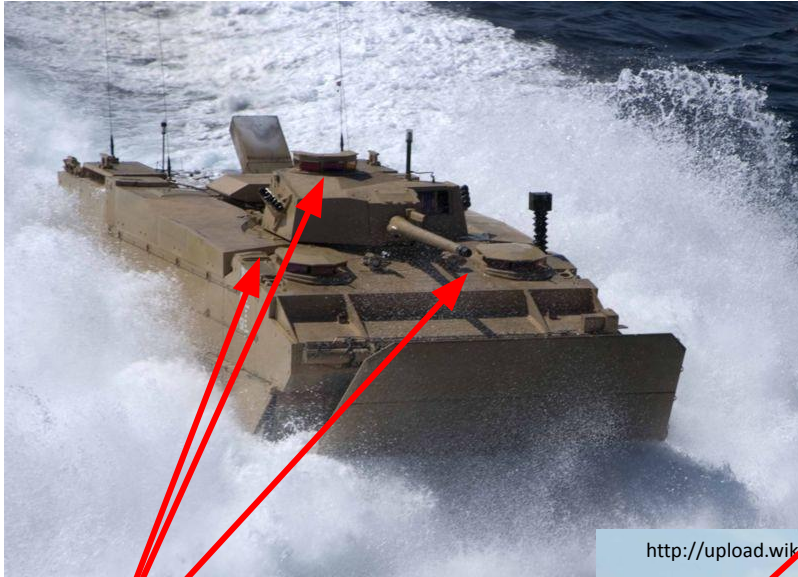

Hatches

<http://science.howstuffworks.com/enlarge-image.htm?terms=M1+Tank&gallery=1&page=24>



Door

http://upload.wikimedia.org/wikipedia/commons/c/c3/EFV_disembark.jpg



Mobile Bridge



<http://www.army-technology.com/contractors/engineering/man/man4.html>



Class 30 Medium Assault Bridge on the Bionix 25 Infantry Fighting Vehicle.

Actuation Bearings, Platform
Mounting Bearings, and all the
bearings you find on a tank

Ariete Gun Elevation System

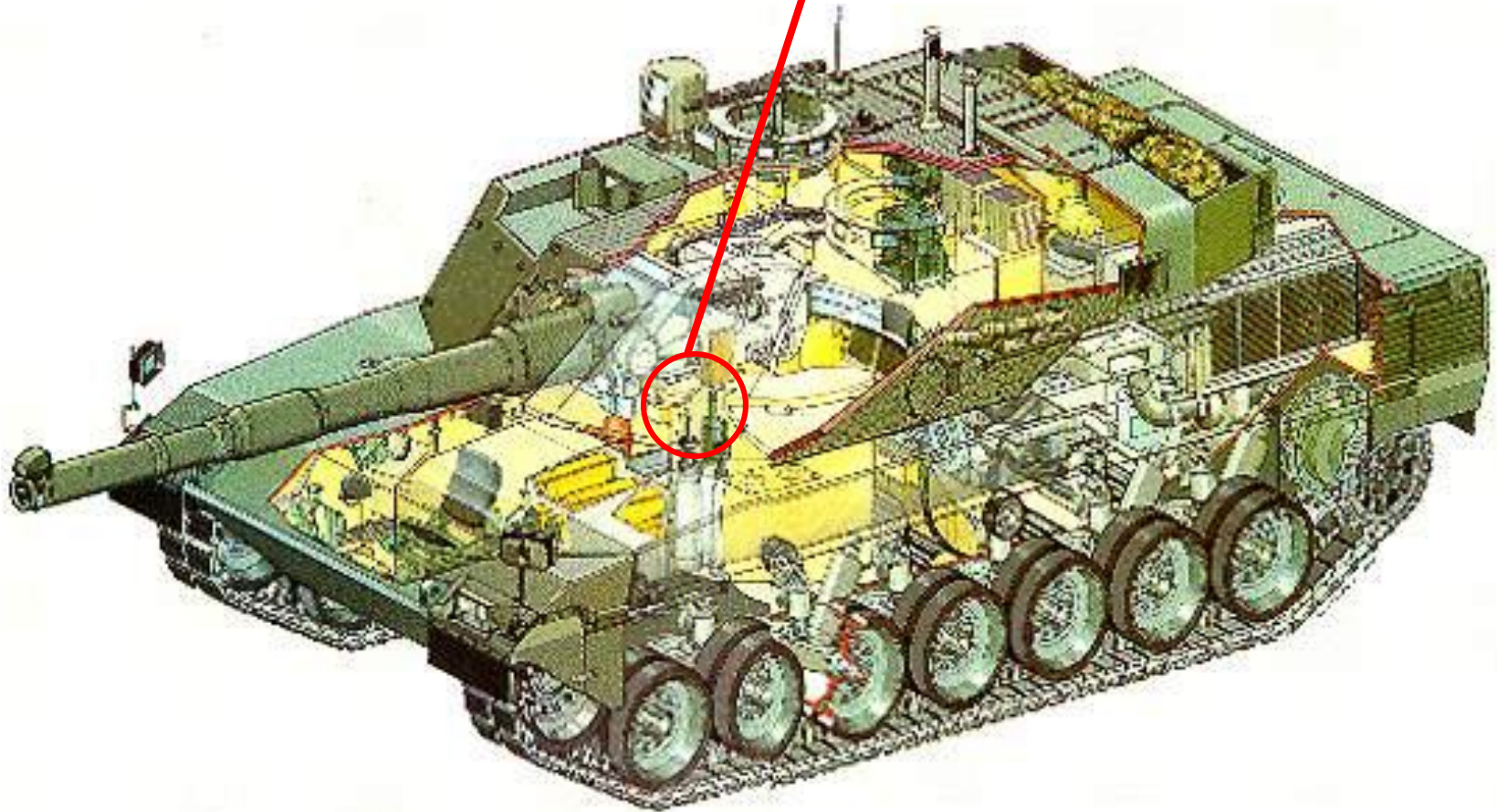



Turret Actuation Bearings



HIMARS Launcher



Stryker MGS



Specialized Bearings

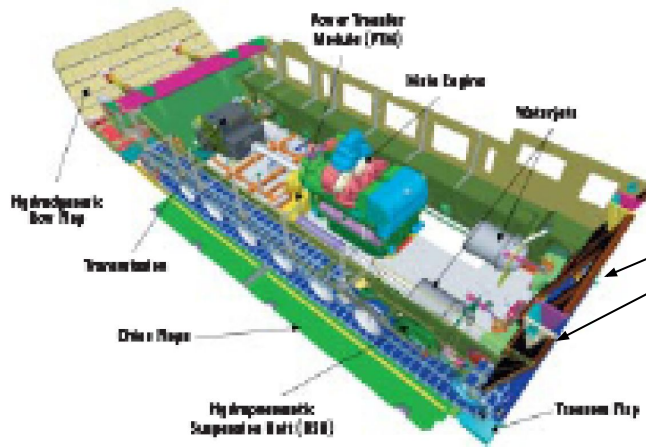

- EFV Rudder actuator
 - Control jet drives in amphibious mode
- Track cover plates,
 - Actuator bearings, hinge journals / bushings
- Bow plates transition for land and water modes
 - Actuator bearings, hinge journals / bushings

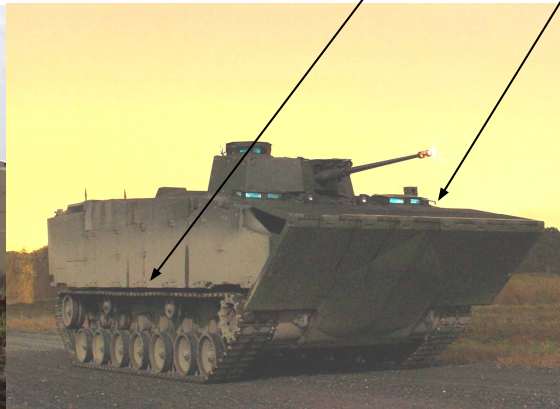

SCHAUBLIN

Solutions



- Drivers
 - Corrosion resistance
 - Salt Spray, Rocket Exhaust Gas, Gun Powder
 - Wear resistance
 - Performance spec defined (cycles vs. wear) that are higher than Industrial Fiberglide performance limits
 - Fluid resistant
 - Oils, fuels, coolant, de-ice
 - Water contamination
 - Polyester liners are best (Fiberglide VI)
 - Fatigue resistance
 - Cyclic or Reversing Loads
 - High strength
 - Not carbon steel, U.T.S. requirements over 90 ksi
 - High temperature
 - Over 200 deg. F
 - Minimal envelope
 - Because size does matter

Special Products



- Liners for water
 - Fiberglide VI (TDC / Heim) and Dyflon (SWP)
- High temperature (>450 deg.F)
 - Fabroid X, Fabroid XV
- Wear Resistance
 - Fibriloid, Uniflon E, Kentlon, M889
- Low Friction
 - Fabroid II, Fabroid IIG2
- Machinable
 - Uniflon HP
- Thick, moderate wear resistance
 - Industrial Fiberglide

Other land vehicles equipped with independent suspension systems



- Farm Tractors

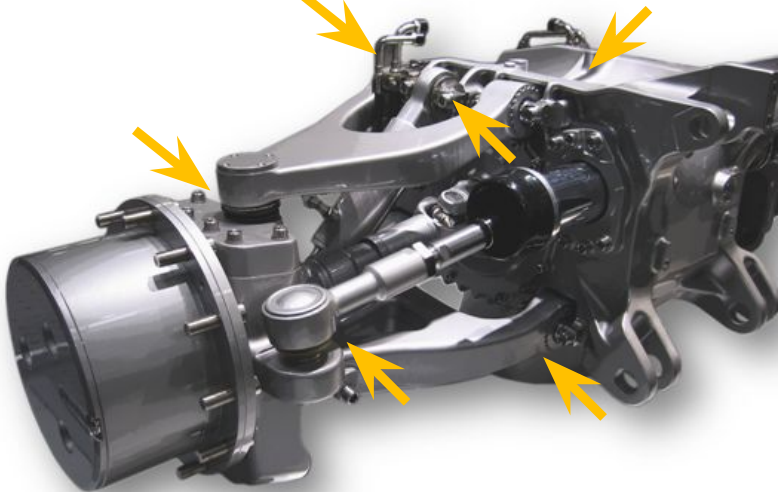

Other land vehicles equipped with independent suspension systems



- Rally cars and sports cars
 - Suspension wishbones are using selflubricating spherical plain bearings
 - The Unibal® brand name is one of the most known for good quality product



Unibal
Swiss made by SCHAUBLIN

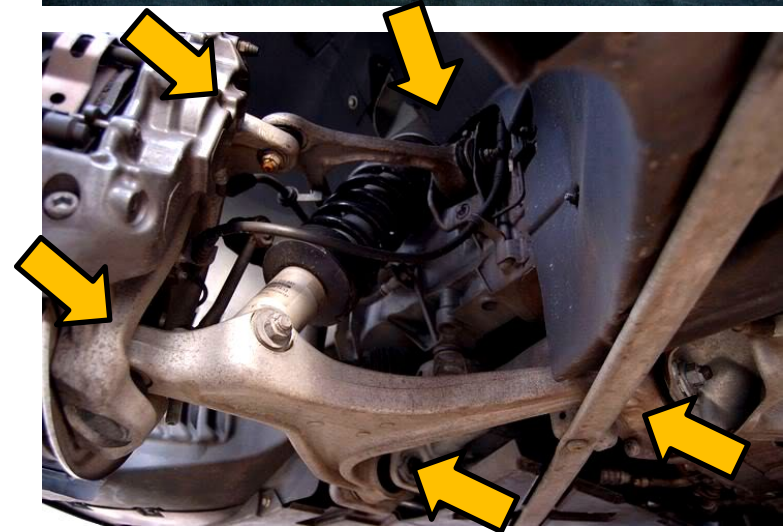

SCHAUBLIN



Other land vehicles equipped with independent suspension systems



- Formula 1
 - Independent suspension system uses spherical bearings and bushings



Swiss made by SCHAUBLIN

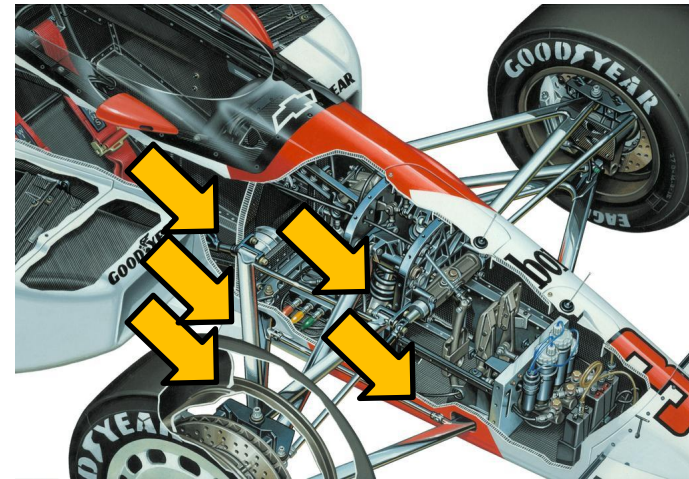
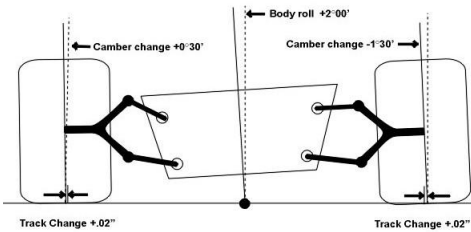
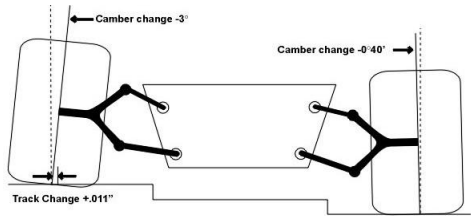

SCHAUBLIN



RBC-Bearings

SCHAUBLIN

Suspension systems solutions



Suspension system products



Engineering Support

We offer a variety of engineering services from the selection of bearing materials to in-house testing of bearing assemblies.

Quality Assurance

Schaublin is certified to the standard for industrial, railway and aerospace industries

- ISO 9001
- EN 9100 / EN 9120
- IRIS (Q2/2014)

Numerous applications

- Suspension pivot joints
- Damper attachments
- Anti roll bar linkages
- Shock absorber joints
- Tilt mechanism and actuation systems
- Independent suspension axle systems
- Wishbone bearings
- Racing cars, rally cars
- All Terrain Vehicles
- Military vehicles



Independent Suspension Systems

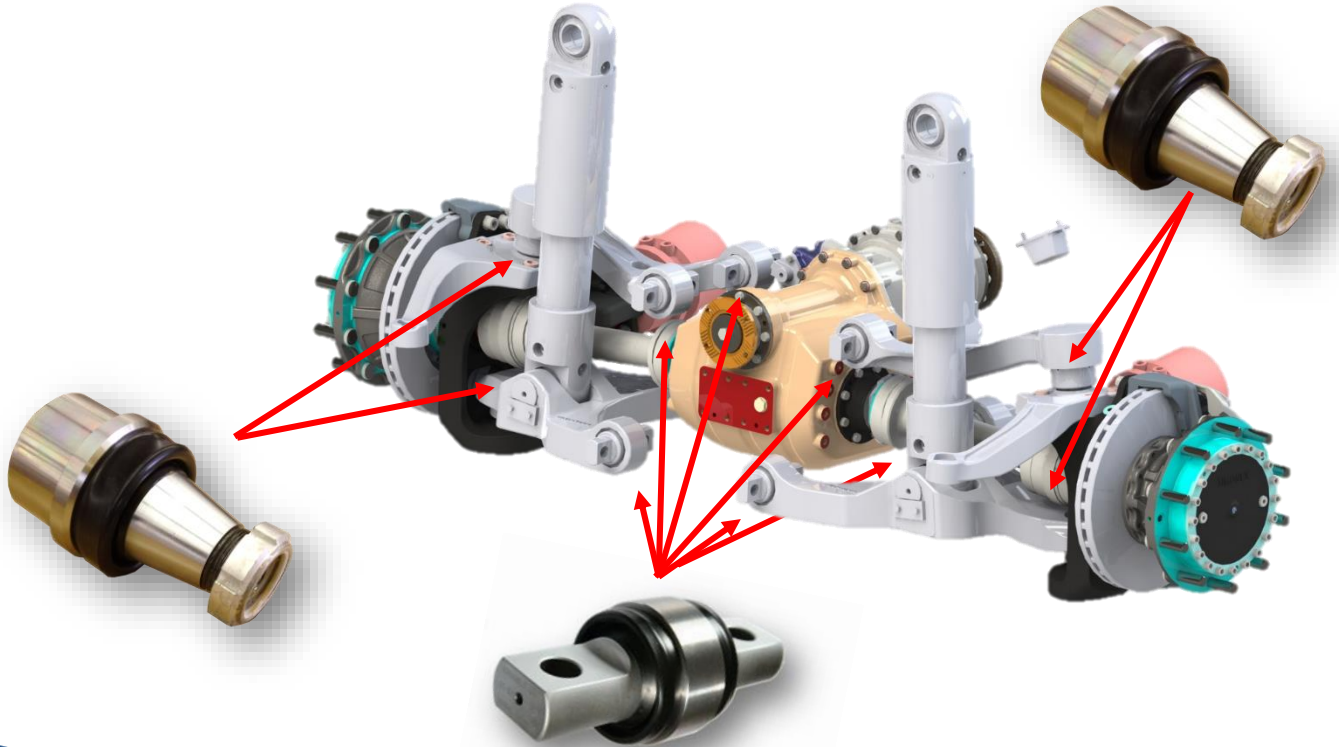

Independent Suspension Systems



Independent Suspension Systems

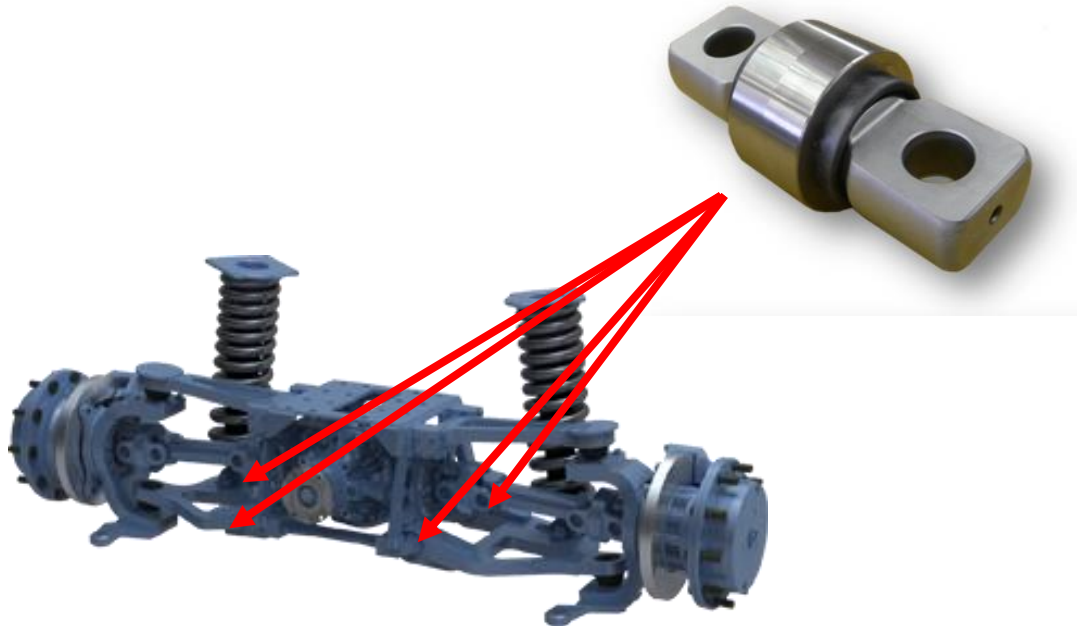

Independent Suspension Systems

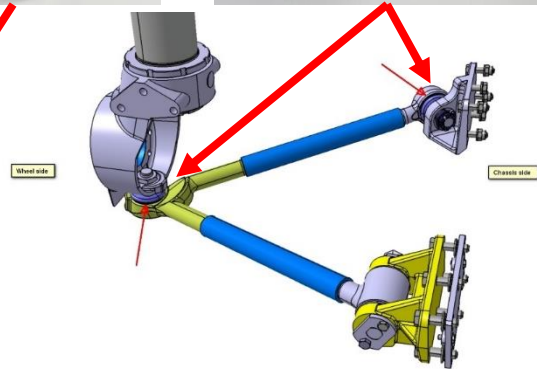
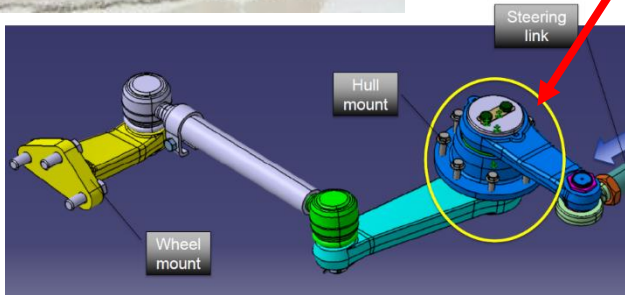

Kingpin Linkage – Steering System

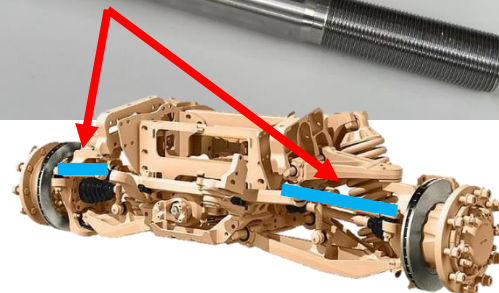
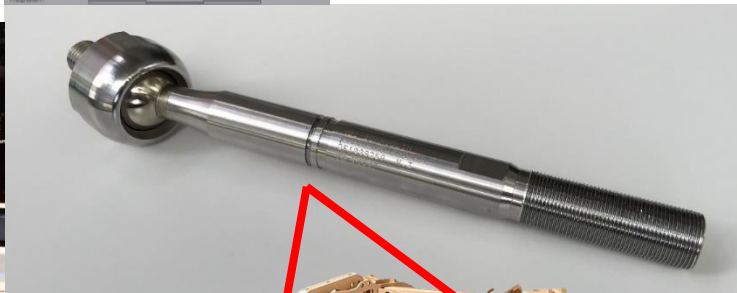
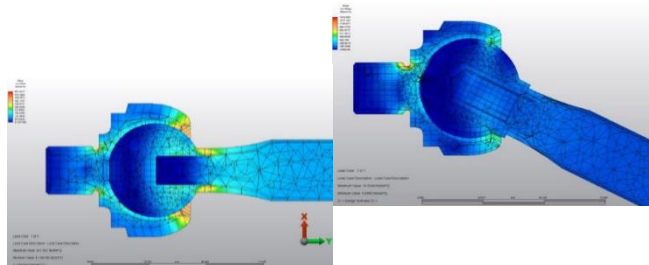

MRAP – Independent Suspension



Wheel Bearing (4 per axle)

Tie Rod End Bearing (4 per axle)

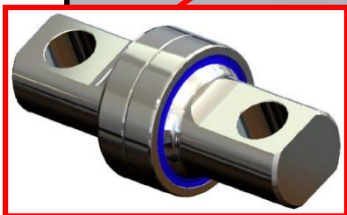
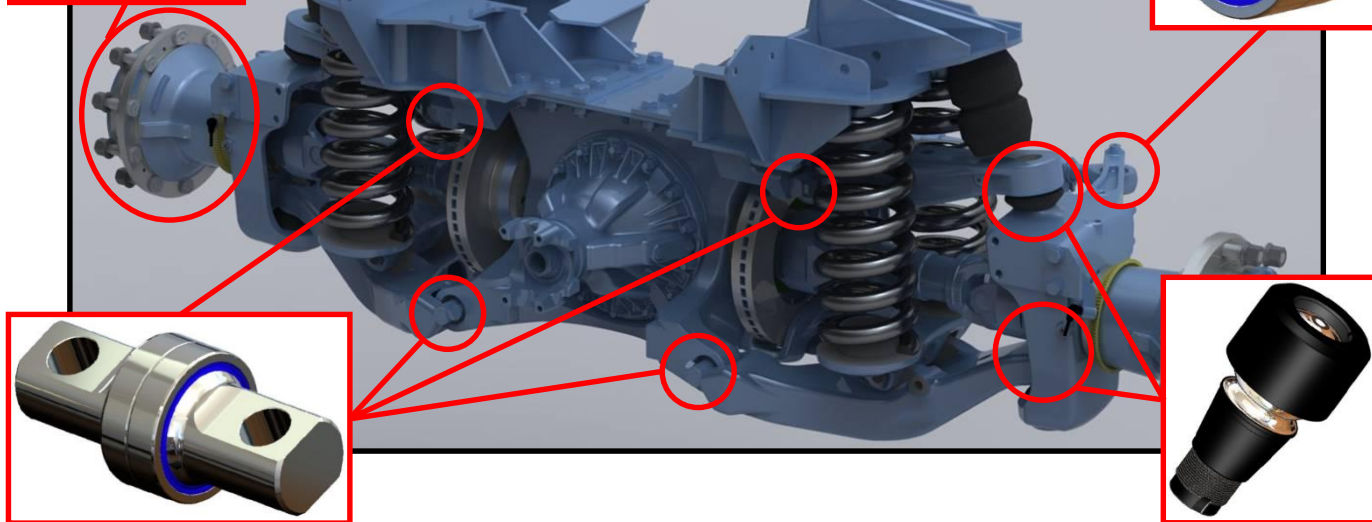

Upper/Lower Control Arm Pivot (8 per axle)



Ball Stud Assembly (4 per axle)

MRAP – Suspension details

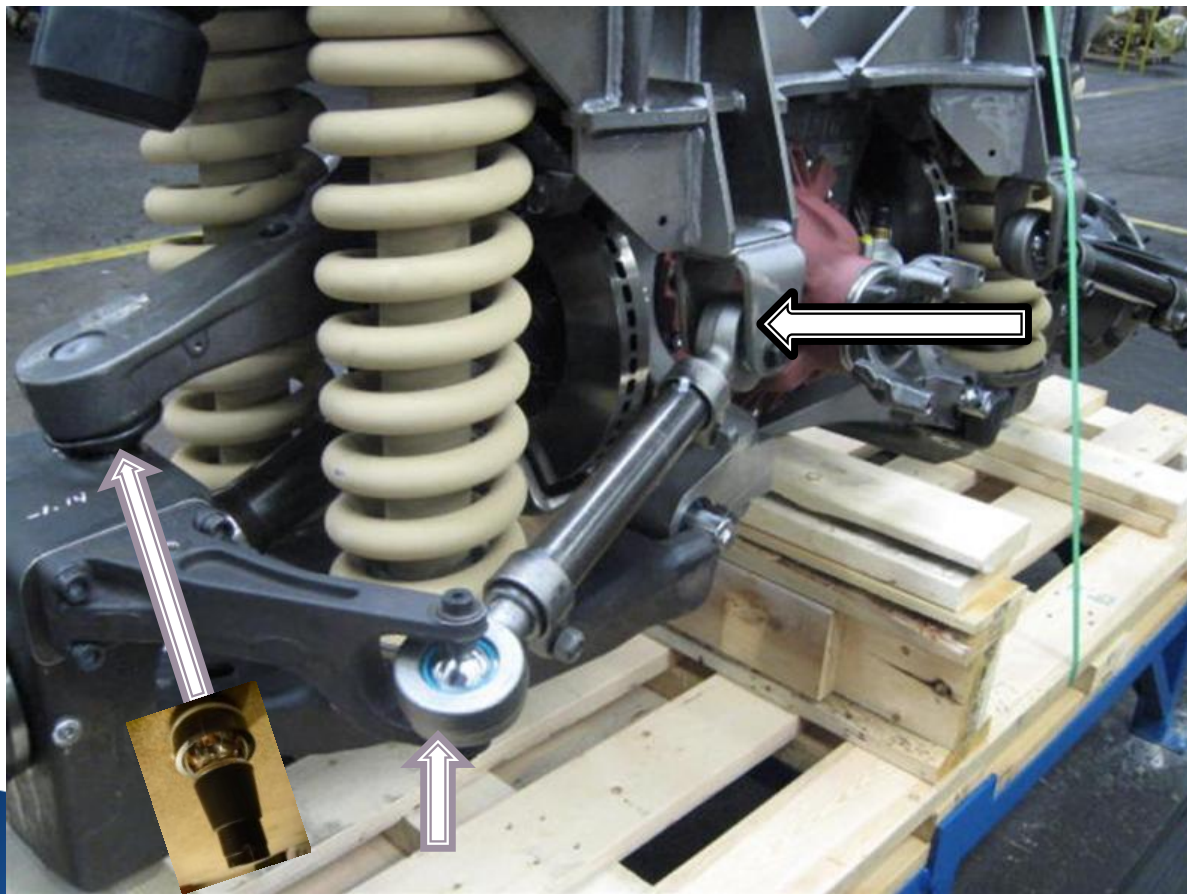

MRAP – Suspension ball stud

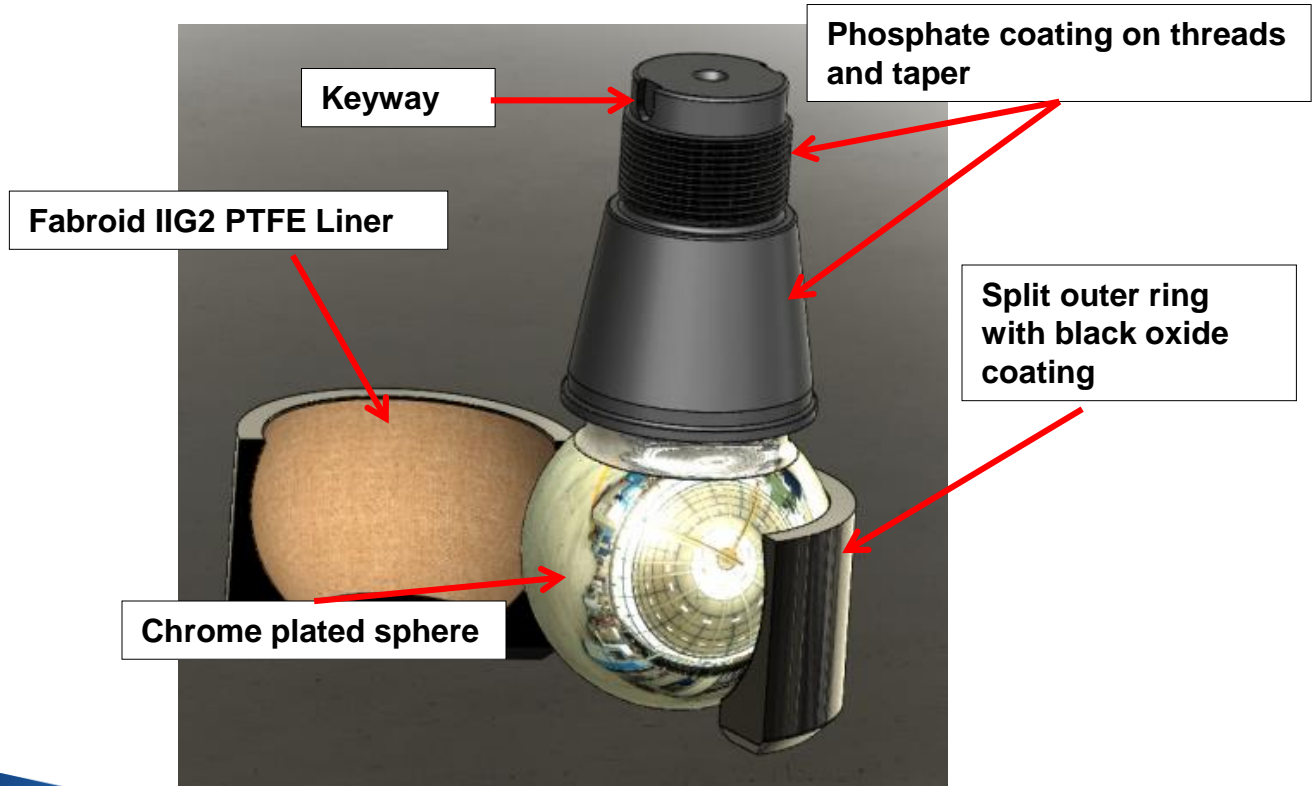

Military Transport Vehicles

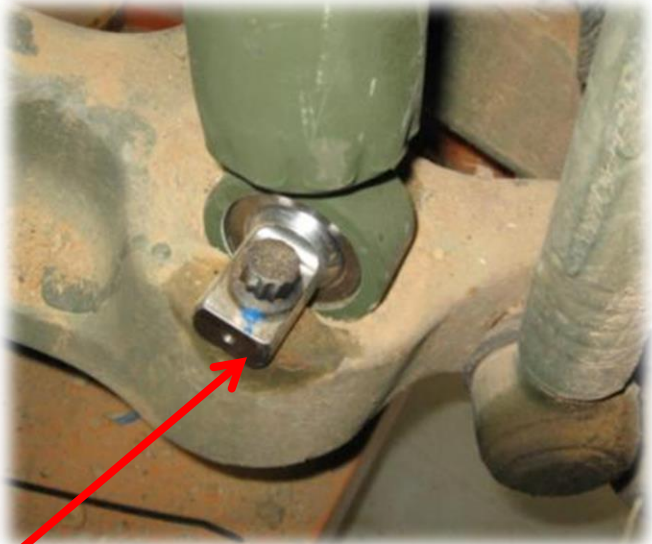

Tactical Vehicles



Struts

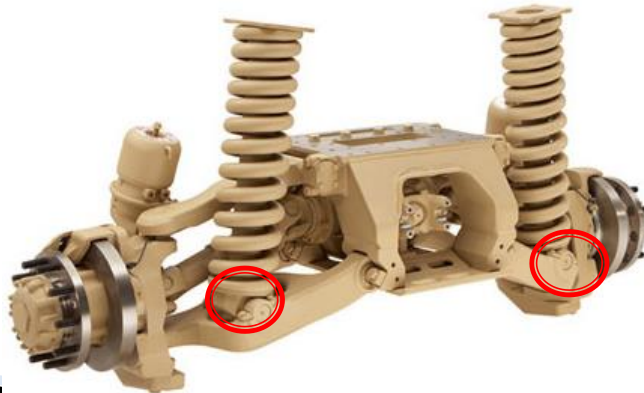

Applications of Schaublin Bearings

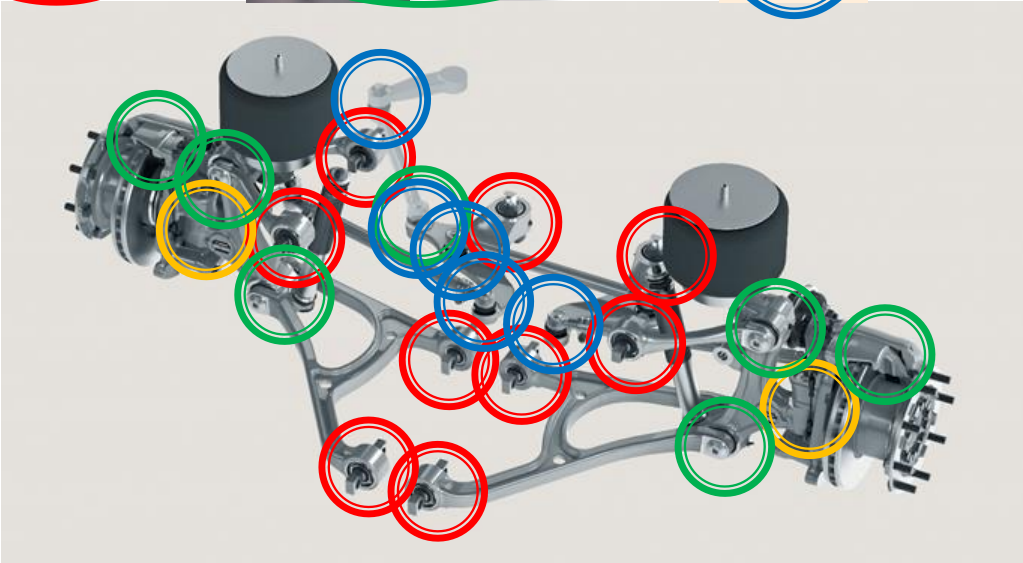

▶ Farm Tractors

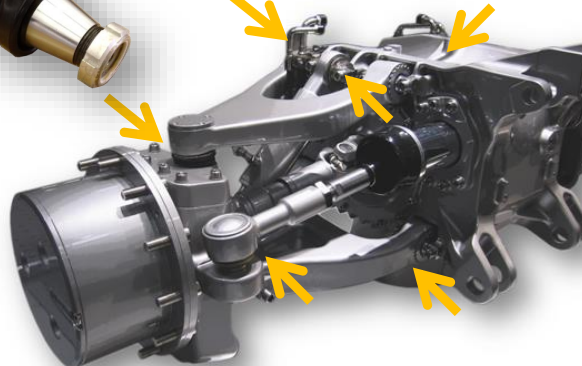

- ▶ Rally cars and sports cars
 - Suspension wishbones are using selflubricating spherical plain bearings
 - The Unibal® brand name is one of the most known for good quality product

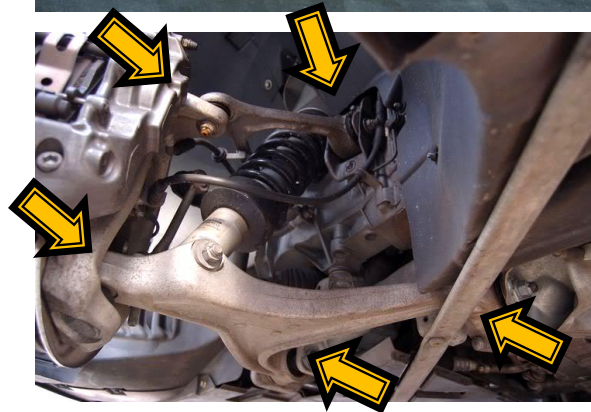

Other land vehicles equipped with independent suspension systems



▶ Formula 1

- Independent suspension system uses spherical bearings and bushings



Swiss made by SCHAUBLIN

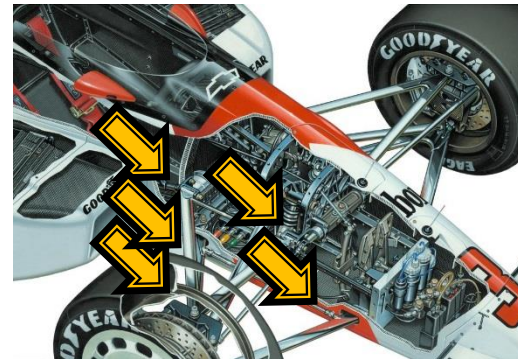
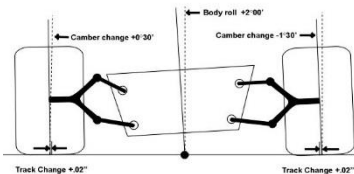
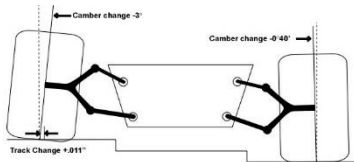

RBC[®]
BEARINGS

SCHAUBLIN



Typical Articulated Truck Positions

Hinge Bushings



Panhard Link Bearings



Steer Cylinder Bearings
Suspension Cylinder Bearings



Articulation Bearings
A-Frame Bearings



Hoist Cylinder Bearings
(Upper/Lower)

