

HIGH-PRECISION BALL BEARINGS

# High-Precision Ball Bearings

## Product Catalog

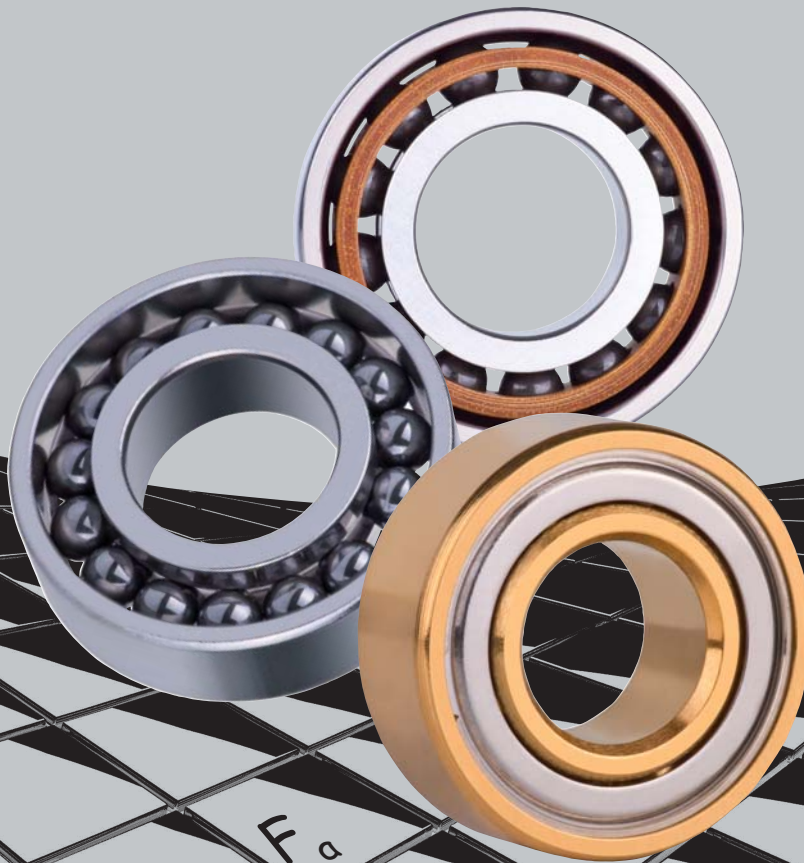

$$\Delta S_{RÜ} \approx k \cdot \ddot{u}$$

$$P_r = X \cdot F_r + Y \cdot F_a$$

$$L_{nm} = a_1 \cdot a_{iso} \cdot L_{10}$$

$$\Delta S_{RT} \approx \Delta d_o - \Delta d_i - 2\Delta D_w$$

$$L_{10} = \left( \frac{C}{P_r} \right)^3$$

## Designation system of radial ball bearings – metric / inch

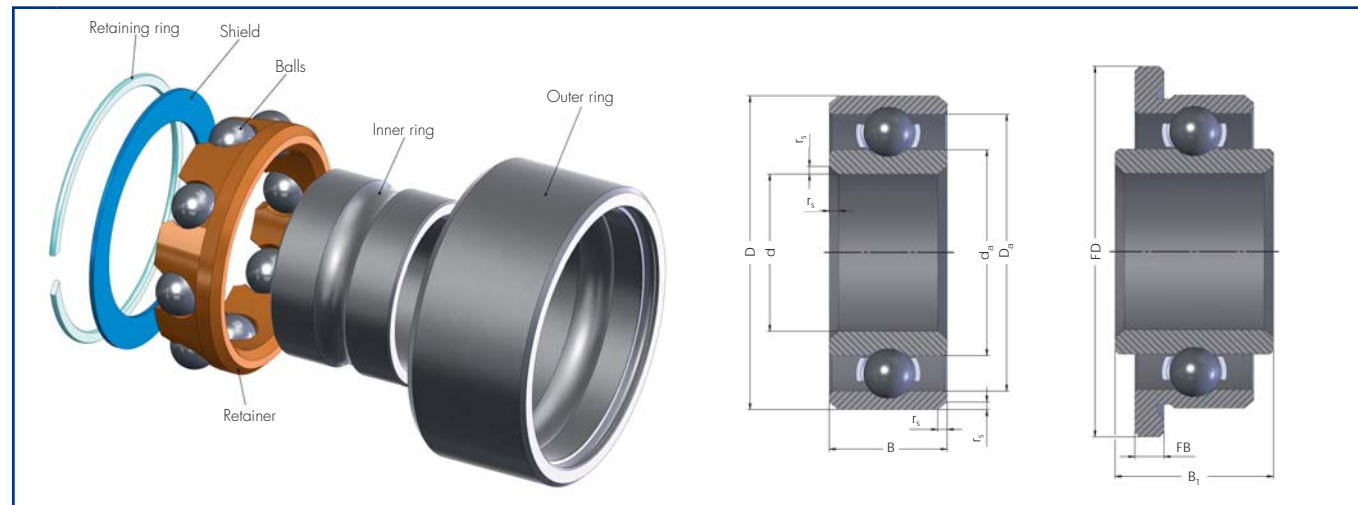

				Closure			
-	-	LE	625	-	P...	C...	
HY	SS	F	3/16	-Z	ABEC...	K...	
ZO	SV	E	625/603938	-2Z		D...	
	S			-RZ			
	SA			-RS			
	N			-VZ			
	NZ			-VS			
				-TS			
-	Steel balls	LE Bearing unit	625 Metric	-	Open ball bearings	Standard tolerance grade P0 or ABEC1 not marked	Metric deep groove radial bearings
HY	Ceramic balls made from Si <sub>3</sub> N <sub>4</sub>	F Flange	3/16 Inch	-Z	Single shield	P tolerance grade for metric bearings in P6, P5, P4 and P2	- Standard clearance C2 Narrower than standard C3 Slightly increased radial clearance C4 Increased radial clearance C5 Strongly increased radial clearance
ZO	Ceramic balls made from ZrO <sub>2</sub>	E Extended inner ring	625/XXXXXX Acc. to drawing	-2Z	Double shield	ABEC tolerance grade for inch bearings in ABEC3, ABEC5 etc.	The exact values depend on the bearing dimensions, see chapter "The classification of radial clearance".
	Combination balls			-RZ	Single Perbunan rubber shield, non-contact	ABEC tolerance grade for inch bearings in ABEC3, ABEC5 etc.	Defined radial clearance: f.e. C1/5 1 to 5 µm C4/8 4 to 8 µm C10/15 10 to 15 µm C14/20 14 to 20 µm
	Full ceramic bearings (balls, IR, AR) of silicon nitride			-RS	Single Perbunan rubber contact seal	Special tolerance grades: ABEC9P, P4A, P4S,...	Inch deep groove radial bearings Defined radial clearance: f.e. K02 0 to .0002" K13 .0001" to .0003" K46 .0004" to .0006" K58 .0005" to .0008"
	Full ceramic bearings (balls, IR, AR) made from zirconium oxide			-VZ	Single Viton shield, non-contact		D Followed a by number indicates contact angle
				-VS	Single Viton contact seal		Spindle ball bearings C Contact angle 15° E Contact angle 25°
				-TS	Single Teflon® contact seal		
	Further materials available on request						

## Designation system of radial ball bearings – metric / inch

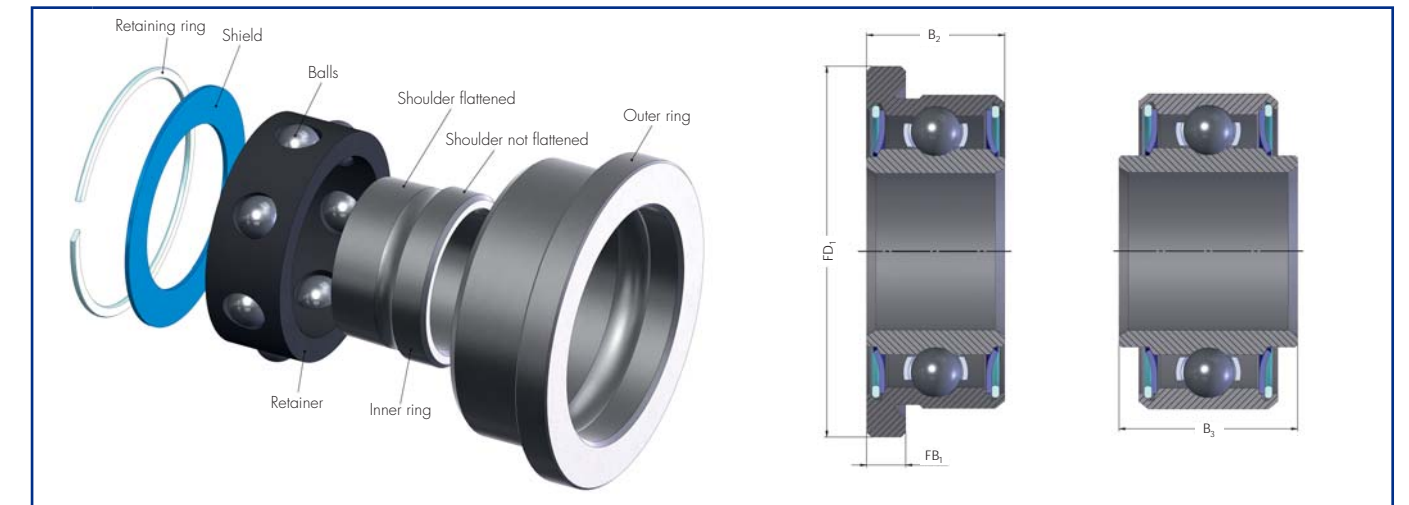

GPR	X	-1	/...	E	-	G...					
GPA	XB	-2	L	J	...%	L...					
R(...)	XD	-3	M	J1	... MG	L299					
	X4	-4	S	TXHB		B...					
	X4B			TXA							
	X4D			...							
GPR	Noise test (standard 100%)	X	Bore and outside diameter graded in 2 classes	-1	Back to back (O-arrangement)	/...	Preload value in [N]	Deep groove radial bearings	-	No data	G... Grease
GPA	Axial vibration test	XB	Bore graded in 2 classes	-2	Face to face (X-arrangement)		Preload for spindle ball bearings	E	2-pc. steel retainer	Standard quantity	L... Oil
R(...)	Followed by a number indicates starting torque with standard load, max. 16 µNm	XD	Outside diameter graded in 2 classes	-3	Tandem		...	J	2-pc. stainl. steel retainer	...% Lubricant quantity in % of the free space only for lubricated bearings)	L299 dry bearing
		X4	Bore and outside diameter graded in 4 classes	-4	Universally paired		L light M medium S strong	J1	2-pc. stainl. steel hybrid retainer	...MG Lubricant quantities specified in mg or indication of quantity range e.g. 10–15% or 6–10MG	B... Special treatment
		X4B	Bore graded in 4 classes				Preload other than L, M, S possible	TXHB	Machined one-piece snap retainer, X stands for a number and defines the material		
		X4D	Outside diameter graded in 4 classes					TXA	Machined synthetic snap retainer made from XTRAlon		
								Example: T19HB Machined synthetic snap retainer made from XTRAlon			
								For information about TXA and other retainer variants see chapter "Retainers for miniature ball bearings"			
								Full complement ball bearing			
								VAC1 Full complement			
								VAC2 variations			
								VF			
								Spindle ball bearings			
								AC1 Outer ring shoulder ground			
								AC2 Inner ring shoulder ground			
								Example: AC1TA Outer ring shoulder grounded & machined solid retainer made from fabric-reinforced phenolic resin			
								Example: UM (= universally matched pairs, medium preload)			

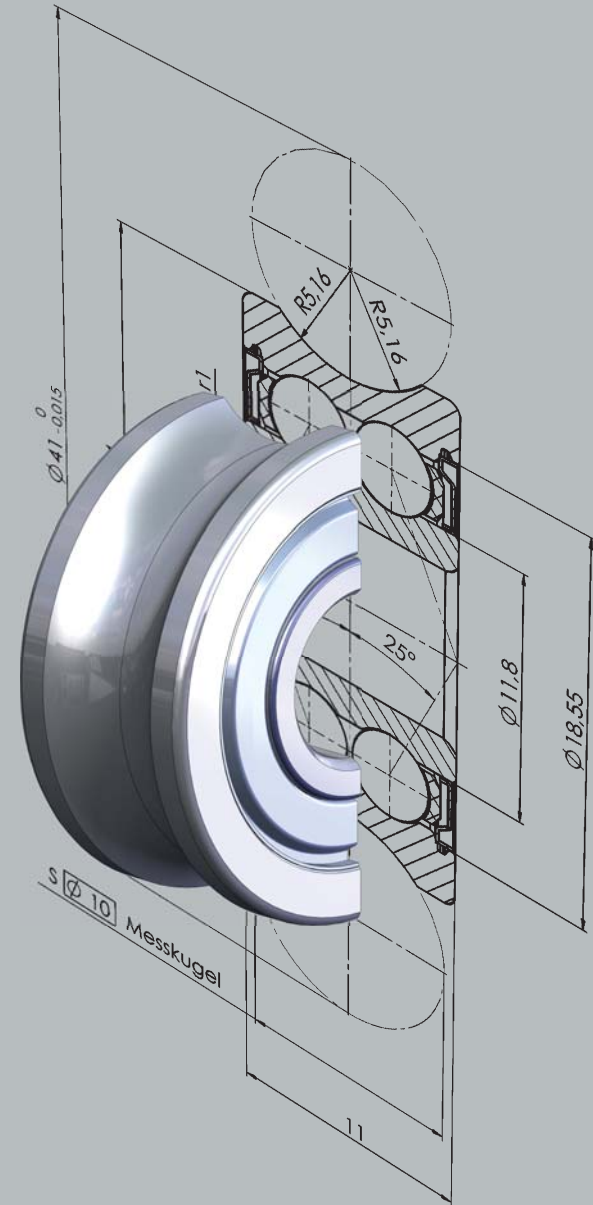

## Contents

<b>Our Company</b>	2	Profiled rollers	72
<b>Preface</b>	3	Bearing units	73
<b>GRW Modular System</b>		Thin-section bearings	74
Materials for rings and balls	4	Hybrid and full ceramic ball bearings	75
Closures	5	Special ball bearings	76
Retainers for miniature ball bearings	6	Coated bearings	78
Lubricants	8		
<b>Fundamentals of Ball Bearing Design</b>		<b>GRW XTRA</b>	
Shaft and housing shoulders	10	<b>XTRA</b> - Enhancing Performance	80
Special installation configurations	11	<b>XTRAc Coat</b> - The new GRW coating system	81
Fitting tolerances	12	<b>XTRAlube</b> - The lubrication for longer life	81
Load ratings and L-10 life	14	<b>XTRAlon</b> - The premium retainer material	82
Limiting speeds	16	Your success with GRW <b>XTRA</b> bearings	83
Elastic behavior of deep groove radial bearings	17		
Relationship between radial play, axial play, contact angle and tilting angle	18	<b>Accessories</b>	
Calibration of bore and outside diameters	19	Shims	84
Reduction in radial play	20	Spring washers	84
Radial play classification	23	Retaining rings, shaft circlips, bore retaining rings	86
Functional tests	24		
<b>Ball Bearing Portfolio</b>		<b>Service</b>	
Tolerance and runout tables – inner ring	26	Test equipment – Orakel III / Speedmaster	88
Tolerance and runout tables – outer ring	28	GRW laboratory services	89
Designation system for radial ball bearings – metric / inch	Cover	Correct handling of GRW high-precision miniature bearings	90
Deep groove radial ball bearings – metric	30	Packaging	92
Deep groove radial ball bearings – inch	52	GRW quality: International Certification DIN EN ISO 9001	93
Spindle / angular contact bearings	58	<b>Manufacturing in a Nut Shell</b>	94
Duplex bearings	59	<b>Index</b>	96
Installation and configuration of duplex ball bearings	60		
Designation system for spindle ball bearings	62		
Spindle ball bearings	64		

## Our Company

As a global corporation with more than 500 employees, GRW is headquartered in Rimpar, near Würzburg, with assembly facilities in Prachatice (Czech Republic) and a direct sales office in the USA.

GRW is the premier developer and manufacturer of miniature precision ball bearings, assemblies and accessory parts utilizing state-of-the-art equipment and manufacturing processes. We specialize in production of high precision, small, miniature and instrument bearings as well as spindle bearings and bearing units. GRW also welcomes the opportunity to design, develop and produce customized applications using customer specifications.

Our radial ball bearings range in bores from 1 mm to 35 mm with outer diameters from 3 mm to 47 mm meeting any condition from mini series to high volume standard applications.

GRW bearings are produced in both metric and inch dimensions making them truly applicable to any customer in the world. Whether your application requires mini series, standard high volume or customized specifications, you can always rely upon GRW to meet any requirement or challenge.

GRW complies with the highly recognized standard of quality in process and performance as evident by our ISO certification, DIN EN ISO 9001:2008.

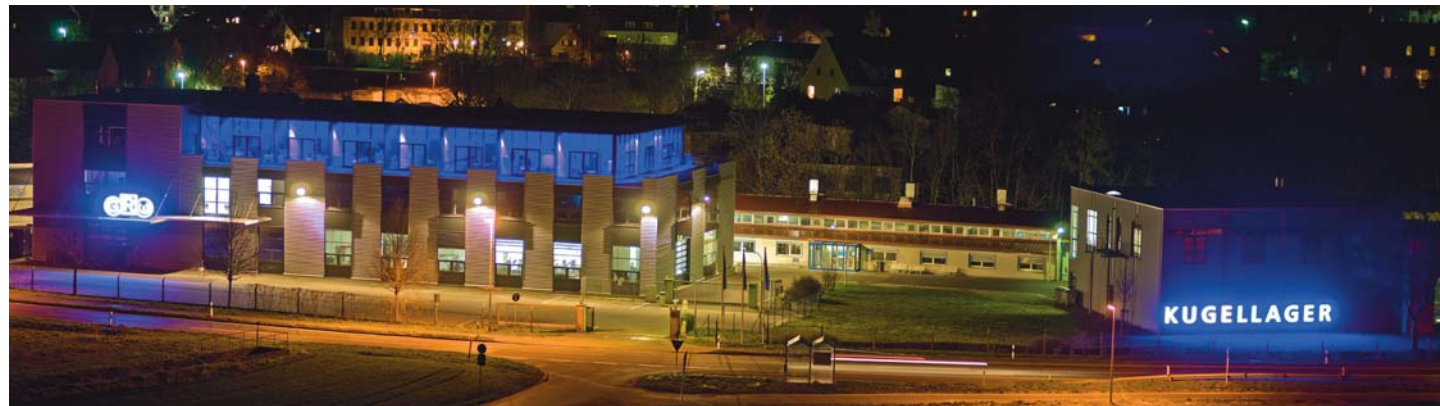

Headquarter and production site at Rimpar

## Preface

### “Miniature precision meets extreme demands”

In order to successfully meet the challenges of the market, our products are being continuously developed and their performance improved, based on the latest innovations from GRW.

Developments that we have achieved in the areas of product design, ball bearing steels, retainer design and materials, lubricants and surface coatings, are the basis for the technological leadership the company has today.

Our latest advance: **XTRA – Enhancing Performance!**

With GRW **XTRA**, we are not so much reinventing the ball bearing but using our expertise to improve, for example, performance levels in terms of running noise, service lifetime and speed! The ball bearing designed by GRW to your individual requirements acquires superior performance due to **XTRA**.

See page 79 of this product catalog for more details.

We can do even better – just challenge us.  
Our sales engineers are available to consult with you.  
We are looking forward to your call:  
USA: +1 (804) 328 0900  
Worldwide: +49 (0) 93 65/819 – 440



**2013**  
Construction of the new production site in the Czech Republic  
Opening of new sales office on the East Coast of the USA

**2011**  
Formation of GRW Academy

**2009**  
Relocation of the administration to the new administrative building in Rimpar

**2003**  
Formation of GRW USA

**2001**  
Reorganization of the corporate strategy in terms of in-house production and cooperative production

**1998**  
Restructuring in the Czech Republic

**1996**  
Purchase and construction of production site in the Czech Republic

**1987**  
Extension of Rimpar site buildings III and IV

**1962**  
First cleanroom assembly in Rimpar

**1958**  
Factory construction in Rimpar (Buildings I and II)

**1942**  
Company founded in Würzburg



**GRW... the premier provider  
for customized high-precision ball bearing solutions.**

## Materials for rings and balls

GRW ball bearings are manufactured by using technological advancements in steel production and heat treatment. Our ball bearings are made of chrome steel (100Cr6), stainless steel (X65Cr13), or high corrosion-resistant steel (X30CrMoN 15-1). It is now possible to achieve comparable load ratings for all these steel types.

Ceramic balls, e.g. hybrid ball bearings, can be used in all versions as required by your application.



### Hybrid ball bearings

GRW hybrid, or ceramic ball bearings are made of one of the steels previously mentioned as well as silicon nitride ( $\text{Si}_3\text{N}_4$ ) or zirconium oxide ( $\text{ZrO}_2$ ), both which offer specific benefits.

These types of bearings are used most commonly in dental handpieces, spindle bearings and vacuum pumps to extend speed limits or increase bearing stiffness.

Using GRW  $\text{Si}_3\text{N}_4$  ceramic balls reduces load rating by 30 %, while the dynamic load rating remains unaffected.

The low affinity to other materials allows a particularly low adhesive wear. As a result, hybrid or ceramic bearings provide extended lifetime run times when used in mixed-torque applications.

### Materials for rings and balls

Prefix	Unit	-	SS	SV	HY	ZO
DIN		100Cr6	X65Cr13	X30CrMoN 15-1	$\text{Si}_3\text{N}_4$	$\text{ZrO}_2$
DIN		1.3505	1.4037	1.4108		
SAE		52100				
<b>Properties</b>						
Density	[g/cm <sup>3</sup> ]	7.81	7.7	7.7	3.2	6.0
Hardness	[HRE]	> 60	> 58	> 58	> 75	> 69
E-module	[GPa]	212	220	223	320	200
Expansion coefficient	[x 10 <sup>-6</sup> °C]	11.0	10.5	10.4	3.0	10.5
Corrosion resistance	[ - ]	limited	good	very good	very good	good
Electrical conductivity	[ - ]	conductor	conductor	conductor	insulator	insulator
Magnetism	[ - ]	magnetic	magnetic	magnetic	non magnetic <sup>(1)</sup>	non magnetic

<sup>(1)</sup> May contain magnetic parts for production technology reasons

Our sales engineers will gladly inform you about the chemical resistance properties of the materials. Subject to change.

## Closures

Integrated ball bearing shields and seals provide two vital purposes: to prevent dirt and foreign particles from infiltration and to prevent lubricants from leaking out.

### Non-contact shields

Together with the shoulder of the inner ring, the closure creates a narrow gap. Similar to open ball bearings, this closure neither increases running friction nor limits the maximum permissible speed because the shields do not touch the inner ring. This is sufficient for most applications. Shields prevent contamination with dirt particles but cannot achieve a hermetic seal.

### Metal shields Z

For the majority of our bearings, shields are stamped from corrosion-resistant steel. They are fastened and secured to the outer ring by means of a circlip and can thus be removed. Bearings can also be fitted with pressed-in shields made from a deep drawn steel sheet; these shields cannot be removed.

### RZ/VZ rubber seal

The RZ closure is made of synthetic buna N rubber with a steel support shield and can be used at temperatures from -30 °C to +120 °C.

The VZ closure is made of synthetic Viton fluoroelastomer with steel support shield and can be used at temperatures from -20 °C to +230 °C.

Both shield types are secured by snap fit.

### Contact seals

This type of seal touches the shoulder of the inner ring, causing an increase in start up and running torque.

Teflon® seals can be used at working temperatures of -240 °C to +300 °C. The friction is lower than for rubber seals due to the low friction combination (PTFE /steel) and the low contact force of the sealing lip.

### Teflon® seal TS

The TS seal is made of a glass-fiber reinforced Teflon® sheet that is fastened in the outer ring by means of a circlip.

TS seals are universally resistant to chemicals. Bearings using TS seals are normally made of corrosion-resistant steel. In appropriately large quantities, TS seals can also be made available for chrome steel bearings.

### RS/VS seals

The RS seal is made of synthetic buna N rubber with a steel support shield and can be used at temperatures from -30 °C to +120 °C.

The VS seal is made of synthetic Viton fluoroelastomer with a steel support shield and can be used at temperatures from -20 °C to +230 °C.

Both shield types are secured by snap fit.

### Custom shields and seals

GRW can also manufacture custom accessories and combinations of different shields and seals to meet your specifications.

For improved sealing effect between steel shields and outer ring GRW offers a special laminated shield.

**In this context, we would like to point out that certain lubricants cannot be used with all closures. Please consult our sales engineers about difficult applications.**



## Retainers for miniature ball bearings

Retainers are vital for efficient operation of ball bearings. First, they keep the balls separated and evenly spaced, ensuring a uniform distribution of load and thereby reducing heat while enhancing the bearing life expectancy.

Secondly, the retainer guides the balls in the load-free zone and prevents the balls from dropping out of

separable bearings. Using our customized designs and materials, retainers can be manufactured to meet any application. We recommend usage of a two-part ribbon retainer for the majority of applications.

**In this context, we would like to point out that certain lubricants cannot be used with all retainers.**

See the following list for our range of different retainer variants:

GRW retainer designation	Illustration	Description/ material	Scope of application / purpose
<b>E</b> <b>J</b>		Two-piece retainer made from – steel sheet ( E ) – stainless steel sheet ( J )	E/J: Standard retainer for deep groove radial bearings. For stainless bearings: retainer always made from stainless steel sheet. To avoid torque peaks as far as possible, this retainer can also be mounted in a loosely clamped condition.
<b>JH</b>		Retainer clamping types: – without additional sign = standard – F = retainer tightly clamped – L = retainer loosely clamped  One-piece snap-type retainer made of stainless steel ( JH )	JH: For deep groove radial bearings. Used primarily for small ball bearings and low to medium speeds.
<b>J1</b> <b>XTRAFLOW</b>		Two-piece hybrid material retainer made from – stainless steel sheet ( J1 )	For applications which require minimal friction and long life even at poor lubrication conditions.
<b>TNH</b>		One-piece molded synthetic snap retainer.	For deep groove radial bearings in medium speed range with good running and torque characteristics. Working temperature from -30°C to +80 °C, short term up to +100 °C.
<b>TNXH</b>		One-piece molded synthetic snap retainer made from glass fiber reinforced plastic. X stands for a number and defines the material.	For deep groove radial bearings in a speed range above that of the TNH retainer. Working temperature from -30°C to +120 °C, short term up to +180 °C.
<b>THA</b> <b>THB</b>		Machined one-piece snap retainer made from fiber-reinforced phenolic resin. A = outer ring guided B = inner ring guided	For deep groove radial bearings with very high speeds. High rigidity and emergency running properties. Working temperature from -50°C to +130°C. Can be impregnated with oil.
<b>TXHA</b> <b>TXHB</b> <b>XTRAlon</b>		Machined one-piece snap retainer made from a special material. X stands for a number and defines the material. A = outer ring guided B = inner ring guided	For deep groove radial bearing with very high speeds. High rigidity and emergency running properties. Working temperature, depending on the material, up to +250°C or even +300°C.
		These retainer can also be ordered with our new retainer material <b>XTRAlon</b> , for even longer service life! Please find more information about <b>XTRAlon</b> on page 82.	

GRW retainer designation	Illustration	Description/ material	Scope of application / purpose
<b>L1T</b> <b>L2T</b>		L1T = outer ring separable, inner ring guided  L2T = inner ring separable, outer ring guided	For separable angular contact ball bearings/spindle bearings with highest speeds. High rigidity. Working temperature from -50 °C to +130 °C. Can be impregnated with oil.
<b>L1TX</b> <b>L2TX</b> <b>XTRAlon</b>		L1TX = outer ring separable, guided on inner ring L2TX = inner ring separable, outer ring guided X stands for a number and defines the material.	For separable angular contact ball bearings/spindle bearings with highest speeds. High rigidity and emergency running properties. Working temperature, depending on the material, up to +250 °C or even +300 °C.
		These retainer can also be ordered with our new retainer material <b>XTRAlon</b> , for even longer service life! Please find more information about <b>XTRAlon</b> on page 82.	
<b>TA/TB</b>		Machined one-piece solid retainer made from fiber-reinforced phenolic resin. A = outer ring guided B = inner ring guided Only used with AC types. Non-separable.	For angular contact bearings/spindle ball bearings with highest speeds. High rigidity and emergency running properties. Working temperature from -50 °C to +130 °C. Can be impregnated with oil.
<b>TXA/TXB</b> <b>XTRAlon</b>		Machined one-piece solid retainer made from a special material. X stands for a number and defines the material. A = outer ring guided B = inner ring guided Only used with AC types. Non-separable.	For angular contact bearings/spindle ball bearings with highest speeds. High rigidity and emergency running properties. Working temperature, depending on the material, up to +250 °C or even +300 °C.
		These retainer can also be ordered with our new retainer material <b>XTRAlon</b> , for even longer service life! Please find more information about <b>XTRAlon</b> on page 82.	
<b>VAC1</b> <b>VAC2</b>		Full complement bearing, without retainer, cannot be disassembled. VAC1 = shoulder relieved on outer ring VAC2 = shoulder relieved on inner ring Outer ring or inner ring shoulder ground on one side.	Used for medium speeds, high radial loads and high axial loads in one direction.
<b>VF</b>		Full complement ball bearing, without retainer, non-separable, with filling slot for inserting the balls.	Used for medium speeds and high radial loads.

As not every retainer is available for all sizes, please contact us for additional information. We will gladly recommend other bearing and retainer designs as well as retainer materials for special requirements.

GRW offers some of the highest performance synthetic materials including **Vespel®**, **Torlon®**, **PEEK**, **PTFE** and **Meldin®** as well as various metallic materials and phenolic resins.

In addition to using proven materials, GRW, in close cooperation with its customers and suppliers, is constantly

developing new options or enhancing existing variations. As a result, GRW is the sole owner of some exclusive licenses and patents for using specifically developed retainer materials such as the new developed premium material **XTRAlon**. Detailed information concerning **XTRAlon** you can find on page 82.

## Lubricants

### Why do bearings need lubricants?

Miniature ball bearings are perfect for high stress environments, but require special lubricants to minimize wear, in order to increase operational life, performance, and safety of the product.

GRW lubricants provide permanent lubrication to minimize sliding friction between balls, rings and retainer. This prevents excessive wear and thermal overheating, protecting balls and raceway from micro-welding and thereby extending operational life while reducing running noise. The bearing application specification determines the best type of lubrication to use.

### Grease lubrication

Thanks to their ability to dispense a lubricating film over time, grease lubricants offer an additional advantage when being used in maintenance-free applications.

Most of GRW bearings are grease-lubricated, with approximately 300 different greases to select from. The standard recommended amount of grease (lubricant quantity) is one-third (33%) of the remaining free space in the bearing. Grease quantities deviating from this standard are indicated in the bearing part number just before the type of lubricant, preferably in percent or alternatively in milligrams.

Furthermore, our customers can choose other special treatments for grease applications, for example a



dispersion or a thin defined layer of grease. Here the designation system differentiates between TF (thin film), MF (medium film) and SF (strong film).

### Oil lubrication

Miniature bearings lubricated with oil may offer advantages over those lubricated with grease.

Oil is primarily used in applications where a minimal torque is required. In particular, high speed spindle bearings are typically lubricated with high performance oils.

When compared to grease lubrication, oil lubrication sometimes uses a dispersion of oil and a solvent to achieve a better distribution of oil throughout the bearing.

With more than 100 special oils to choose from, GRW can help you to select the oil that perfectly matches your application. If no special lubrication is needed, all of our bearings whether open or shielded, are preserved with light instrument oil when they leave our factory.

### Proper lubrication practices

At GRW, all bearings are lubricated during final assembly under clean-room conditions. Since dust particles can cling to the oiled or greased bearings, it is important that the customer maintains a high standard of cleanliness in their application. In addition we recommend using a clean-room for removal of the bearings from their package and during assembly.

With greased bearings, the specified quantity of lubricant, accurate to milligrams, is injected directly into specified locations of the miniature ball bearing. Usually the lubricant is injected from only one side, however it is also possible to lubricate each bearing from both sides for better distribution.

For lubrication with standard oils, the oil is poured over the bearing which is then spun. Alternatively, a specified oil quantity can be directly injected into the bearing.

### Solid lubricants

Non-lubricated bearings may be used in certain applications and are also available from GRW. These non-lubricated bearings are typically required for ultra-high vacuum (UHV) temperature extremes and for applications in aviation and aerospace. Here the operating conditions go beyond the functional limits of oil and grease lubricants. The use of a bearing without a protective lubricant will negatively impact its tribological system; however lubrication with solids is a viable alternative.

GRW offers its customers a variety of different dry film coatings. Applying thin layers of precious, Wolfratherm® or MoS<sub>2</sub> provides protection and lubrication for the bearing.

For oil or grease lubricated bearings, this process ensures reliable performance in case of lubricant deprivation (emergency running conditions). In GRW's part numbering system, the surface treatment of bearing components is indicated by a "B", followed by a four-digit number code indicating the type of surface treatment.

### Custom treatments

In addition to varying lubricants and surface treatments, GRW can custom treat bearing components to improve tribological behavior. For example, the phenolic retainer can be vacuum-impregnated with oil (up to 5% by weight). The benefit of a vacuum-impregnated retainer is its ability to release small amounts of lubricant continually during operation. This process improves the general lubrication performance and ensures emergency running properties in lube deprived situations.

### Lubricants in medical applications

Sterilization (autoclaving) is mandatory for the proper use and maintenance of medical instruments according to the guidelines of the Robert-Koch Institute. This applies to the hygienic treatment of surgical devices and dental turbines that depend on miniature ball bearings.

GRW's stainless steel and retainer materials can easily withstand sterilization in an autoclave subjected to superheated steam, where most lubricants do not survive. Combined with the extreme high speed stresses of dental turbines, these lubricants are required to provide exceptional surface adhesion and sterilization resistance.

As manufactured, GRW bearings utilize a range of lubricants that are resistant to the sterilization process and well suited for dental and surgical devices. This optimization results in a longer life under extreme environmental conditions.

### XTRAlube

For enhanced performance and longer life time we recommend the new by GRW developed lubrication **XTRAlube**.

More information about **XTRAlube** you can find on page 81.

## Shaft and housing shoulders

Certain design and assembly factors are critical for optimum performance of bearings. For instance, shaft and housing shoulders should accurately allow axial load to be transferred to the inner and outer ring without permitting the rings to tilt in opposite directions.

The associated dimension tables provide limits for the largest ( $d_{a\ max}$ ) and the smallest ( $d_{a\ min}$ ) permissible shoulder diameter for the inner ring and the largest permissible shoulder diameter for the outer ring ( $D_{a\ max}$ ).

See Dimension Tables on pages 30 to 57.

Please note the following considerations:

- The housing shoulder diameter for the outer ring must always be smaller than ( $D_{a\ max}$ ) and the shaft shoulder diameter at the inner ring must not be smaller than ( $d_{a\ min}$ ).
- The corner radius between fit and shoulder must not be larger than the corner clearance ( $r_{s\ min}$ ) of the bearing. Here an undercut is preferable to a corner radius. The edge radii of the bearing are not designed as a locating surface for the bearing in any way.
- The axial runout of the mating surfaces should not be greater than the maximum axial runout of the bearing used. Otherwise the function of the bearing will be compromised.

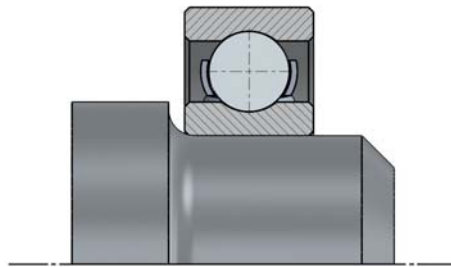

Wrong, Shaft radius greater  $r_{s\ min}$

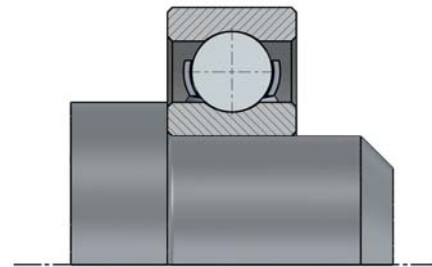

Correct, Shaft radius smaller than  $r_{s\ min}$

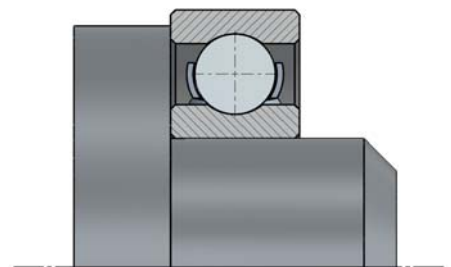

Wrong, Shaft shoulder greater than  $d_{a\ max}$

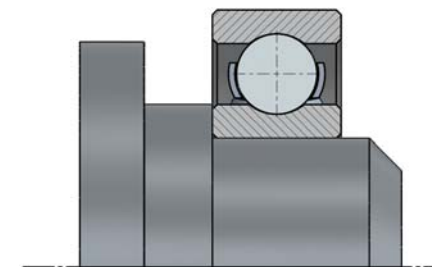

Correct, Shaft shoulder equal with inner ring shoulder

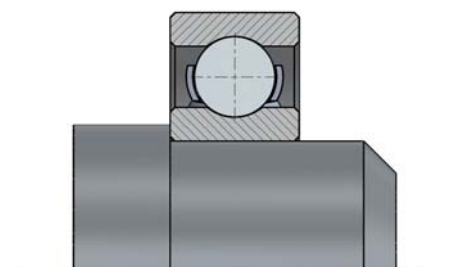

Wrong, Shaft shoulder smaller than  $d_{a\ min}$

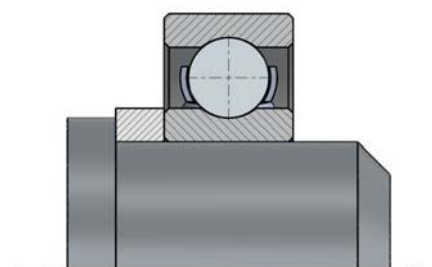

Correct, Support ring in place

**Note:** Similar examples apply to bearing housings.

## Special installation configurations

### Flanged bearings

Using miniature and instrument bearings with a flange on the outer ring offers several advantages.

Stepped housing bores, which make it impossible or very difficult to maintain accurate alignment of both bearing fits, are no longer necessary. There is also no need for the use of circlips, which create difficulties in small housing bores or thin-walled housings.

Flanged bearings assembled in narrow housings, such as gearboxes, are particularly effective.

With paired bearings, the use of a flanged bearing simplifies the proper assembly and alignment of the bearing.

This allows for the accurate axial positioning of the Duplex bearing pair.

### Bearings with extended inner rings

Bearings with an extended inner ring simplify design and mounting of various assemblies. Shims, washers and other spacers are not necessary. Stepped shafts are also redundant.

### Bearings with reinforced outer ring

Ball bearings whose outer rings are supported by the proper housing fit can withstand the highest loads. To increase the load capacity of a bearing which is not pressed into a housing, it takes advantage of a reinforced outer ring. These types of bearings can be used as "rollers".

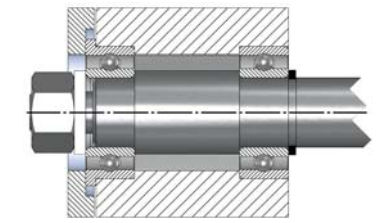

Proper installation, general

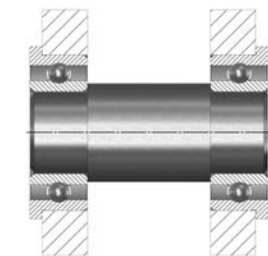

Assembly in narrow housings

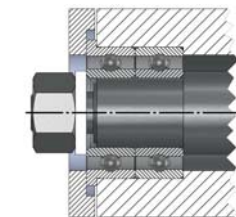

Application of a Duplex bearing

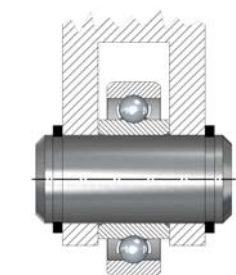

Bearings with extended inner ring

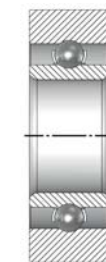

Bearings with reinforced outer ring



## Fitting tolerances

Among other factors, the fit of the bearing on the shaft and in the housing significantly affects the operational behavior of miniature ball bearings. When selecting fitting tolerances the following criteria should be considered:

### Rotation conditions

Rings with circumferential loading should have a tighter fit than rings with a single point load. Circumferential loading occurs when the ring is rotating and the load is static, or when the ring is static and the load is rotating.

Point loading occurs when the rings and loads are both static, or when the rings and loads are both rotating in the same direction with equal speed. Please refer to the table "Shaft tolerances" and "Housing tolerances".

### Running accuracy

The same high standards of accuracy and surface quality applicable to the bearings must be applied to the shaft and housing bore.

### Loading

Higher loads require a tighter fit between ball bearing, shaft and housing.

### Temperature

There may be temperature differences between the bearing and mating components while the bearing is in operation. Dimensional changes caused by differential thermal expansion should be considered when selecting a bearing.

With miniature bearings it is very important to select the proper fit for the highest accuracy and reliability, hence only a close sliding or transition fit is generally required. In addition irregularities on the shaft or in the housing bore are transferred to the relatively thin-walled bearing rings.

In order to improve the fit, it is possible to classify and sort the bore and outside diameters into groups (also refer to the chapter "Calibration of bore and outside diameters"). The values shown in these tables "Shaft tolerances" and "Housing tolerances" are only valid for materials with the same expansion coefficient ( $11 \times 10^{-6} 1/K$ ). For different expansion coefficients, or when there are temperature differences between the bearing rings and the shaft or housing, a tolerance should be selected which ensures the appropriate fit at operating temperature.

**Note:** For certain environmental conditions, an adhesive may be used to secure the bearing rings. Please contact our sales engineers for additional information.

### Recommended fittings

The recommended fits listed below assume mean tolerances obtained from empirical performance data.

#### Shaft tolerances

Bearing bore Quality → Tolerance in $\mu\text{m}$ Tolerance in .0001 inch → Operating conditions	P0 <b>0/-8</b> 0/-3	P5 <b>0/-5</b> 0/-2	Grading		Type of fit
			<b>0/-2.5</b> 0/-1	<b>-2.5/-5</b> -1/-2	
Low load Medium speeds No oscillations	<b>-5/-13</b> -2/-5	<b>-5/-11</b> -2/-4	<b>-5/-8</b> -2/-3	<b>-8/-11</b> -3/-4	Slide fit
Low to medium loads Medium speeds Low oscillations	<b>0/-8</b> 0/-3	<b>0/-6</b> 0/-2.5	<b>0/-3</b> 0/-1.2	<b>-3/-6</b> -1.2/-2.5	Tight fit
High loads High speeds Oscillations at high frequency	<b>+4/-4</b> +1.6/-1.6	<b>+4/-2</b> +1.6/-1	<b>+4/+1</b> +1.6/+1.4	<b>+1/-2</b> +.4/-1	Press fit

Subject to change.

#### Housing tolerances

Ball bearing outer diameter Quality → Tolerance in $\mu\text{m}$ Tolerance in .0001 inch → Operating conditions	P0 <b>0/-8</b> 0/-3	P5 <b>0/-5</b> 0/-2	Grading		Type of fit
			<b>0/-2.5</b> 0/-1	<b>-2.5/-5</b> -1/-2	
Low load Medium speeds No oscillations	<b>+5/-3</b> +2/-1.2	<b>+5/-1</b> +2/-1.4	<b>+5/+2</b> +2/+1	<b>+2/-1</b> +1/-1.4	Slide fit
Low to medium loads Medium speeds Low oscillations	<b>0/-8</b> 0/-3	<b>0/-6</b> 0/-2.5	<b>0/-3</b> 0/-1.2	<b>-3/-6</b> -1.2/-2.5	Tight fit
High loads High speeds Oscillations at high frequency	<b>-4/-12</b> -1.6/-5	<b>-3/-9</b> -1.2/-3.5	<b>-3/-6</b> -1.2/-2.5	<b>-6/-9</b> -2.5/-3.5	Press fit

Subject to change.

#### Note:

The information on this page applies to steel shafts and housings. If applicable, linear expansion coefficients of other materials (e.g. aluminum housings) must be taken into consideration for other operating temperatures.

For more information on grading, refer to the chapter "Calibration of bore and outside diameters".

## Load ratings and L-10 life

### The static radial load rating $C_{0r}$

The basic static radial load rating ( $C_{0r}$ ) applies to bearings which rotate at very slow speeds, which are subjected to slow oscillations or are stationary under load. Per DIN ISO 76, the basic static radial load rating is the static radial load corresponding to a calculated contact stress of 4200 N/mm<sup>2</sup> at the center of the contact ellipse of the most heavily loaded ball or raceway. If the contact pressure exceeds this maximum permissible value, plastic deformation will occur affecting the efficient operation and the life of the bearing. In other words, the basic static radial load rating is the maximum allowable radial load for the bearing. The basic static radial load rating for hybrid bearings with Si<sub>3</sub>N<sub>4</sub> balls will be approximately 30 % lower than for steel ball bearings.

### Static bearing capacity

Static loads including radial and axial components must be converted into the static equivalent radial load ( $P_r$ ) to assess the static bearing load capacity. ( $P_r$ ) is the static radial load which causes the same contact stress at the center of the contact ellipse of the most heavily loaded ball or raceway which occurs under actual load conditions. It is defined as follows:

$$P_r = X \cdot F_r + Y \cdot F_a$$

$P_r$  : Static equivalent radial load [N]

X : 0,6

Y : 0,5

$F_r$  : Largest radial load occurring [N]

$F_a$  : Largest axial load occurring [N]

Where:  $P_r = F_r$  if  $P_r < F_r$

### Basic dynamic radial load rating $C_r$

According to DIN ISO 281, the basic dynamic load rating ( $C_r$ ) for radial ball bearings is the constant radial load at which a sufficiently large group of apparently identical bearings can endure one million revolutions before showing evidence of material fatigue.

### Fatigue load limit $C_v$

The fatigue load limit ( $C_v$ ) is defined as the radial load under which no material fatigue will occur. For ball

bearings manufactured with commonly used high-quality materials, the fatigue load limit is reached at a contact stress of approximately 1500 N/mm<sup>2</sup>.

The load ratings calculated in this Product Catalog have been computed using a curvature of 52-53 % according to DIN ISO 281. Depending on the bearing geometries, the actual load ratings may differ.

### Nominal life $L_{10}$

The "nominal life" ( $L_{10}$ ) of a group of apparently identical ball bearings is the life in millions of revolutions, or number of hours, that 90 percent of the group will complete or exceed before the first evidence of material fatigue occurs. For a single bearing, ( $L_{10}$ ) also refers to the life associated with 90 percent reliability.

This calculation per ISO DIN 281 assumes identical operating conditions including a constant lubricating film separating the ball complement from the raceway during the entire life of the bearing.

The L-10 life of miniature ball bearings is calculated as follows:

$$L_{10} = \left( \frac{C_r}{P_r} \right)^3$$

$L_{10}$  : basic rating life for a reliability of 90 %  
[10<sup>6</sup> revolutions]

$C_r$  : basic dynamic radial load rating [N]

$P_r$  : dynamic equivalent radial load fatigue occurs.

Taking a constant speed for granted, then the number of revolutions may also be expressed as L-10 life in hours ( $L_{10h}$ ):

$$L_{10h} = \frac{10^6}{60 \cdot n} \cdot \left( \frac{C_r}{P_r} \right)^3$$

with

$L_{10h}$  : basic rating life L10 [h]

n : speed of the inner ring [min<sup>-1</sup>]

$C_r$  : basic dynamic radial load rating [N]

$P_r$  : dynamic equivalent radial load [N]

### Extended modified rating life $L_{nm}$

In addition to the nominal life rating ( $L_{10}$ ), DIN ISO 281 introduced an extended modified life rating ( $L_{nm}$ ), and adds a life coefficient ( $a_1$ ) and operating conditions ( $a_{ISO}$ ). In application, life rating may be considerably higher or lower than the nominal L-10 life ( $L_{10}$ ). The following correlation applies:

$$L_{nm} = a_1 \cdot a_{ISO} \cdot L_{10}$$

$L_{nm}$  : extended modified rating life [10<sup>6</sup> revolutions]

$a_1$  : Rating life coefficient for a requisite reliability deviating from 90 %

$a_{ISO}$  : Rating life coefficient for consideration of operating conditions

$L_{10}$  : basic rating life for a reliability of 90 %  
[10<sup>6</sup> revolutions]

### Rating life coefficient for Reliability $a_1$ acc DIN ISO 281

Reliability %	$L_{nm}$	$a_1$
90	$L_{10m}$	1
95	$L_{5m}$	0.64
96	$L_{4m}$	0.55
98	$L_{3m}$	0.47
98	$L_{2m}$	0.37
99	$L_{1m}$	0.25
99.2	$L_{0,8m}$	0.22
99.4	$L_{0,6m}$	0.19
99.6	$L_{0,4m}$	0.16
99.8	$L_{0,2m}$	0.12
99.9	$L_{0,1m}$	0.093
99.92	$L_{0,08m}$	0.087
99.94	$L_{0,06m}$	0.080
99.95	$L_{0,05m}$	0.077

The standardized calculation method for the life rating coefficient ( $a_{ISO}$ ) takes the following factors into account:

- load on the bearing
- lubrication condition
- fatigue limit of the material
- geometry of the bearing
- internal stress of the bearing
- environmental conditions

### Significance of the life rating for miniature ball bearings

All standardized methods for calculating the L-10 life assume that failure is attributable to material fatigue. However, this type of failure occurs very rarely in miniature ball bearings. Rather, miniature ball bearing malfunctions are usually attributed to contamination, retainer wear or lubricant failure. Therefore, L-10 life is theoretical and merely a guide. When estimating the L-10 life of a miniature ball bearing, the exact environmental conditions of the application should be considered.

## Limiting speeds

Various mechanical and kinematic factors impact the maximum operational speed of a bearing. The following factors can have an effect on the limiting speed:

- Retainer load
- Noise
- Rolling kinematics
- Lubrication
- Heat generated by friction and the environment
- Inner ring slippage and radial play reduction

### Retainer loading

In miniature bearings, the speed limit can be determined among other factors by the retainer material and its design.

Practical experience has shown that machined synthetic retainers are better qualified for the highest speeds. These retainers generate smaller imbalance at high speed because of their small mass and the accuracy by which they are manufactured. They are characterized by higher density and elasticity enabling them to withstand the alternating forces generated from ball acceleration and deceleration.

With more than 40 different retainer materials, our product range offers an appropriate technical solution for nearly every application.

### Heat

All bearing assemblies have a maximum operating temperature, which ultimately limits the bearing speed. This maximum temperature is not only defined by the bearing's mechanical components, but also by the temperature range of the lubricant. In general, the operating temperature achieved at a certain speed depends on the torque generated in the bearing and the assembly's ability to transfer heat to the environment.

This assumption is the basis for calculating the thermal reference speed as noted in DIN ISO 15312.

### Thermal reference speed

The thermal reference speed ( $n_{\theta_r}$ ) defines the speed of the inner ring at which a balance is achieved between the heat generated in the bearing by torque and the heat flow dissipated through the shaft and housing.

For the standardized calculation method noted in DIN ISO 15312, the following conditions apply:

- Mean ambient temperature  $\vartheta_{Ar} = +20\text{ °C}$
- Static temperature at the outer ring  $\vartheta_r = +70\text{ °C}$
- Standard bearings without seals
- 5 % of the static load rating as pure radial load
- Lubricant: mineral oil with a kinematic viscosity of  $\nu_r = 12\text{ mm}^2/\text{s}$  at  $\vartheta_r = +70\text{ °C}$

### Significance of the thermal reference speed

The calculation of the thermal reference speed is general and does not take into consideration application specific conditions. As such the thermal reference speed is to be used merely as a guideline value allowing for direct comparison of the different bearing sizes.

Significantly higher speeds can be achieved with special modifications of the components surrounding the bearing and of the bearing itself. Through the use of  $\text{Si}_3\text{N}_4$  (ceramic) balls, a highly accurate synthetic retainer, a higher bearing tolerance grade and a high-performance lubricant, significantly higher speeds can be achieved.

## Elastic behavior of deep groove radial bearings

With ball bearings, two types of deformation have to be distinguished: axial and radial elastic deformation.

### Axial elastic deformation

The axial elastic deformation of a ball bearing is the distance that the inner ring moves axially relative to the outer ring when the axial clearance of the ball bearing has been removed and an increasing axial load has been applied. This value does not increase linearly with increasing axial load; rather the contact ellipses between balls and raceways become larger as the load increases.

### Radial elastic deformation

Similarly the radial elastic deformation is caused by a radial load component after radial clearance has been removed. Under otherwise identical conditions, with a small contact angle, the radial elastic deformation is considerably less than the axial elastic deformation. With an increasing contact angle, the radial yield increases while the axial yield decreases until both values become roughly identical at approximately  $35^\circ$ .

Both types of deformation depend on the internal geometries of bearing, the existing radial clearance and applied load.

### Effect and application

The relatively large amount of yield can be reduced by using preloaded bearing pairs (see chapter "Duplexed bearings"). Preloading will result not only in a reduction of the elastic yield, resulting in increased stiffness, but also in a nearly linear relationship between loading and yield for a considerably wide range of applied loads.

For example: A ball bearing pair with a 10 N preload will maintain linearity up to approximately 30 N of applied axial load. Exceeding this load value will cause the balls to lose contact with the raceway transferring the load to one bearing.

The following formula provides an estimation of the axial preload:

$$F_v \approx F_a / 3$$

$F_v$  : axial preload [N]

$F_a$  : axial bearing load [N]

With a contact angle of  $15^\circ$  (C), the radial stiffness of bearing pairs is assumed to be approximately six times as high as the axial stiffness. With a contact angle of  $25^\circ$  (E), a factor of 2 is assumed.

Specific material properties always play an important role. In hybrid bearings using ceramic balls (e.g.  $\text{Si}_3\text{N}_4$ ,  $\text{ZrO}_2$ ) the material properties of the ceramic balls should be taken into consideration. Due to the lower elasticity of the ceramic material, these bearings are stiffer than bearings assembled with steel balls. The stiffness of bearings using balls made of  $\text{Si}_3\text{N}_4$  is about 30 % higher than the stiffness of bearings using steel balls.

Specific applications must consider the operating temperature which can affect the bearing clearances. Likewise, differing thermal expansion coefficients may play a decisive role in bearing material selection.

For further information, please contact your nearest GRW Sales Representative.

# Relationship between radial play, axial play, contact angle and tilting angle

## Radial play

Radial play has minimal effect on the quality of a bearing; however it does have a significant effect on its performance. For example, the bearing's life rating, running noise, vibrations and thermal behavior all depend on the appropriate radial play. (See chapter: "Reduction in radial play")

Radial play is the measurement of the total movement of one ring relative to the other in a plane perpendicular to the bearing axis. In selecting the appropriate radial play, the fit of the bearing on the shaft and in the housing is of particular importance.

Larger than the standard radial play (4-11 μm) should be selected if the ball bearing runs under axial preload and operates at high speeds, or if low torque is required.

Less than standard radial play should be specified if a radial load is applied or low noise is required.

Less than standard radial play is often specified to reduce the axial play in the application. When a very low axial is required we recommend using duplexed bearings (see the chapter "Duplexed bearings").

In deep groove bearings, there is a definite correlation between radial and axial play that is controlled by the internal geometries. For the individual radial play groupings and their respective references, refer to the section titled "Radial Play Classification".

## Axial play

The axial play is the measured value in which one bearing ring can move axially in relation to the other with no applied load.

## Contact angle

In a load-free condition, the contact angle is called the nominal contact angle. The contact angle is the angle between a plane perpendicular to the ball bearing axis and a line joining the two points where the ball makes contact with the inner and outer raceways. The contact angle of a ball bearing is determined by its radial play, as well as its inner and outer track curvatures.

The contact angle under load is called the operating contact angle. Deformations of a defined size occur at the contact points between balls and raceways. The deep groove radial bearing is a relatively rigid bearing with a very small contact angle range. Here, a highly accurate bearing alignment is of the utmost importance.

## Tilting angle

The tilting angle of a bearing is the relative angle to which the inner and outer rings of a bearing can be tilted. The amount of tilting depends on the radial play and the internal geometries of the bearing.

Tilting of the rings should generally be avoided. Even small tilt angles of 2° or 3° may result in increased bearing noise and reduced life. It is critical to place close attention to machining tolerances of mating assembly components to assure proper bearing alignment.

# Calibration of bore and outside diameters

To guarantee a uniform fit of bearings on the shaft and in the housing, it is imperative to control diameter tolerances of the bearings. It is very difficult to control very small tolerances in a production run; therefore, sorting of the rings may be necessary. Only bearings in quality grades P5 and ABEC5 or better can be sorted into groups of 2.5 μm (.0001 inch) or 1.25 μm (.00005 inch). The diameters of the shaft and housing must also be accurately measured and sorted to match.

For technical reasons, it is not possible to supply bearings in only one specific tolerance group. This means that grading to X4, only 3 of 4 possible groups can be contained in the shipment lot, i.e. the final group distribution is subject to production machining variances.

The following symbols are used for the classification of graded ball bearings:

## Classification of graded bearings

Grading	in groups of 2.5 μm or .0001 inch	in groups of 1.25 μm or .00005 inch	in groups of 1 μm or .00004 inch
Bore d and outside diameter D	X	X4	X5
Bore d only	XB	X4B	X5B
Outside diameter D only	XD	X4D	X5D

### Example:

SS624 P5 GPR X4B J L001

X4B = bore graded in 4 groups of 1.25 μm.

The outside diameter is not graded.

## Key to tolerance groups

	Tolerance field in <b>0.001 mm</b>		Outside diameter D												not graded			
			Tolerance field in <b>.0001 inch</b>		0/-2.5	-2.5/-5	0/-1.25	-1.25/-2.5	-2.5/-3.75	-3.75/-5	0/-1	-1/-2	-2/-3	-3/-4		-4/-5		
			Code	1	2	A	B	C	D	E	F	G	H	I				
Bore d	0/-2.5	0/-1	1	11	12											10	XB	
	-2.5/-5	-1/-2	2	21	22											20		
	0/-1.25	0/-0.5	A			AA	AB	AC	AD								A0	X4B
	-1.25/-2.5	-0.5/-1	B			BA	BB	BC	BD								B0	
	-2.5/-3.75	-1/-1.5	C			CA	CB	CC	CD								C0	
	-3.75/-5	-1.5/-2	D			DA	DB	DC	DD								D0	
	0/-1	0/-0.4	E							EE	EF	EG	EH	EI	EO		X5B	
	-1/-2	-0.4/-0.8	F							FE	FF	FG	FH	FI	FO			
	-2/-3	-0.8/-1.2	G							GE	GF	GG	GH	GI	GO			
	-3/-4	-1.2/-1.6	H							HE	HF	HG	HH	HI	HO			
	-4/-5	-1.6/-2	I							IE	IF	IG	IH	II	IO			
	not graded																	no Symbol
			01	02	0A	0B	0C	0D	0E	0F	0G	0H	0I					
			XD		X4D				X5D									

Different tolerance groups are defined by grading. On the package of each bearing, the relevant group is indicated by means of the following code:

### Examples:

#### Code 21:

Bore-Ø -2.5/-5 μm  
Outside-Ø 0/-2.5 μm

#### Code BC:

Bore-Ø -1.25/-2.5 μm  
Outside-Ø -2.5/-3.75 μm

#### Code A0:

Bore-Ø 0/-1.25 μm  
Outside-Ø not graded

#### Code 02:

Bore-Ø not graded  
Outside-Ø -2.5/-5 μm

## Method of group classification:

Bore diameter: The smallest measured diameter defines the class.

Outer diameter: The largest measured diameter defines the class.

## Reduction in radial play

Ball bearing radial play can increase or decrease during operation due to external influences.

Increases in radial play can cause an increase in contact angle, which distorts the contact ellipse at the transition between raceway and shoulder. This "excessive edge loading" phenomenon may cause premature bearing failure.

In the worst case a reduction in radial play may cause excessive radial preloading of the bearing causing accelerated bearing wear and premature bearing failure.

The following factors have direct influence on changes in radial play:

- Temperature gradients within the bearing or materials with different temperature coefficients.
- Shaft and housing fits.
- Speed related Centrifugal forces.

### Reduction in radial play due to thermal expansion

Bearing clearances are set at an ambient temperature of +20 °C which excludes external loads except measuring loads. Frictional heat generation or temperature differentiation between inner and outer rings can very often cause unfavorable environments. The resulting differential expansions of inner ring and outer ring change the radial play. This factor has to be considered when designing the bearing.

$$\Delta S_{RT} \approx \Delta d_o - \Delta d_i - 2\Delta Dw$$

$\Delta S_{RT}$  : Change in radial play due to thermal expansion [ $\mu\text{m}$ ]

$\Delta d_o$  : Change in outer raceway diameter for temperature T [ $\mu\text{m}$ ]

$\Delta d_i$  : Change in inner raceway diameter for temperature T [ $\mu\text{m}$ ]

$\Delta Dw$ : Change in ball diameter for temperature T [ $\mu\text{m}$ ]

The resultant diameter change caused by the temperature difference is calculated. (Reference: ambient temperature +20 °C):

$$\text{For the outer ring: } \Delta d_o = d_{o0} \cdot \alpha \cdot \Delta T$$

$$\text{For the inner ring: } \Delta d_i = d_{i0} \cdot \alpha \cdot \Delta T$$

$$\text{For the balls: } \Delta Dw = Dw \cdot \alpha \cdot \Delta T$$

$d_{o0}$  : Raceway diameter of outer ring at +20 °C [mm]

$d_{i0}$  : Raceway diameter of inner ring at +20 °C [mm]

$Dw$  : Ball diameter at +20 °C [mm]

$\alpha$  : Linear expansion coefficient [ $\text{K}^{-1}$ ] for

100Cr6 ...  $11 \cdot 10^{-6}$

X65Cr13 ...  $10.8 \cdot 10^{-6}$

X30CrMoN15-1 ...  $10.8 \cdot 10^{-6}$

$\text{Si}_3\text{N}_4$  ...  $3.2 \cdot 10^{-6}$

$\text{ZrO}_2$  ...  $10.0 \cdot 10^{-6}$

$\Delta T$  : Temperature difference between temperature T and ambient temperature of +20 °C in [K]

### Reduction in radial play due to an interference fit

Interference fits cause a reduction in radial play and so the fitting tolerance should be chosen carefully. The reduction in radial play depends on the effective interference fit and the ring thickness ratio. These ratios can be calculated as follows:

$$\Delta S_{R\ddot{U}} \approx k \cdot \ddot{u}$$

$\Delta S_{R\ddot{U}}$  : Reduction in radial clearance due to interference fit [ $\mu\text{m}$ ]

$k$  : Factor from the table, while it is presumed that the inner ring is pressed onto a complete shaft or the outer ring is pressed into a stable, non-deformable housing.

$\ddot{u}$  : Largest interference fit [ $\mu\text{m}$ ]

If interference fits are used on the shaft and on the housing, the total reduction in radial play is determined by adding both values.

### k-factor for inner ring (IR) and outer ring (OR)

metric						inch					
Basic symbol	IR	OR	Basic symbol	IR	OR	Basic symbol	IR	OR	Basic symbol	IR	OR
68/1,5/0003	0.4	0.8	694	0.7	0.8	699	0.7	0.8	1016	0.7	0.8
681	0.6	0.8	604	0.6	0.8	609	0.7	0.8	1191	0.6	0.8
691	0.5	0.8	624	0.6	0.8	629	0.6	0.8	1397	0.6	0.8
68/1,5/0001	0.5	0.8	<b>634*</b>	<b>0.5</b>	<b>0.8</b>	6800	0.8	0.9	5/64	0.6	0.8
68/1,5	0.8	0.8	675	0.9	0.8	6900	0.8	0.9	2380	0.8	0.9
69/1,5	0.5	0.8	675/004	0.9	0.8	6000	0.7	0.8	3/32	0.5	0.9
682	0.7	0.8	694/1002	0.9	0.8	6901	0.8	0.9	3175/0002	0.6	0.9
682/005	0.7	0.8	685	0.8	0.8	6001	0.7	0.9	3175	0.8	0.9
692/003	0.6	0.8	685/003	0.8	0.8	6001/003	0.7	0.9	1/8A	0.7	0.9
692	0.6	0.8	695	0.7	0.8	6802	0.9	0.9	3175/6	0.8	0.6
693/0001	0.5	0.9	605	0.6	0.8	6902	0.8	0.9	1/8A/6	0.7	0.7
67/2,35	0.8	0.8	625	0.6	0.8	6002	0.8	0.9	1/8B	0.6	0.9
68/2,35	0.8	0.9	635	0.5	0.8	6803	0.9	0.9	3175/55	0.8	0.5
67/2,5	0.8	0.9	676/003	0.9	0.9	6903	0.8	0.9	3175/6	0.8	0.6
68/2,5	0.7	0.9	695/1202	0.8	0.9	6003	0.8	0.9	3175/8	0.8	0.4
69/2,5	0.6	0.9	686	0.8	0.9	6804	0.9	0.9	1/8B/083	0.6	0.6
683/0001	0.6	0.9	696	0.7	0.8	6904	0.8	0.9	3967	0.7	0.9
60/2,5	0.6	0.8	625/0002	0.7	0.8	6805	0.9	0.9	4763A	0.9	0.9
673	0.8	0.9	626	0.6	0.8				4763B	0.8	0.9
683	0.8	0.9	688A/1322	0.8	0.9				4763A/082	0.9	0.6
683/003	0.8	0.9	687	0.8	0.9				4763B/083	0.8	0.7
693/003	0.7	0.9	697	0.7	0.8				3/16	0.7	0.9
693	0.7	0.9	607	0.7	0.8				6350A	0.9	0.9
683/8	0.8	0.8	627	0.6	0.8				6350B	0.8	0.9
623	0.6	0.8	688A/142	0.9	0.8				1/4A	0.7	0.8
623/13	0.6	0.6	688	0.8	0.9				1/4	0.6	0.8
633	0.5	0.8	688/003	0.8	0.9				7938	0.9	0.9
674	0.9	0.9	698	0.7	0.8				3/8	0.7	0.8
684	0.8	0.9	608	0.7	0.8				12700B	0.9	0.9
684/103	0.8	0.8	689	0.8	0.9				1/2	0.7	0.8
684/10	0.8	0.8	689/003	0.8	0.9				1/2/001	0.7	0.8

Subject to change.

\* For a detailed example, refer to page 22.

## Reduction in radial play

### Reduction in radial play due to centrifugal forces

At very high shaft speeds or inner ring rotation, the centrifugal forces of the rotating parts increase. The load on the outer ring and the balls also increases and the inner ring expands. The expansion of the inner ring changes the fit of the shaft and bearing and the bearing may begin to slip on the shaft. In this situation, a tighter fit must be selected.

These types of deformations depend on the bearing size, retainer, balls, materials used, and inner geometry of the bearing.

Please contact our sales engineers to find out more about the reduction in radial play due to centrifugal forces.

#### Example:

The ball bearing SS634-2Z GPR J ( $d = 4 \text{ mm}$ ,  $D = 16 \text{ mm}$ ,  $D_w = 2.50 \text{ mm}$ , material of rings and balls: X65Cr13) is to run in an application at 35,000 1/min. During the operating phase, the temperature at the inner ring is  $+60 \text{ }^\circ\text{C}$  and at the outer ring  $+30 \text{ }^\circ\text{C}$ . The ball bearing is mounted on the shaft with a press fit  $j5 (+3/-2)$  and in the housing with a tight fit  $K5 (+2/-6)$ .

#### Change in radial clearance due to thermal expansion:

##### Outer ring:

$$d_{a0} \approx (d+D)/2 + D_w = (4+16) \text{ mm}/2 + 2.50 \text{ mm} = 12.50 \text{ mm}$$

$$\Delta d_a \approx d_{a0} \cdot \alpha \cdot \Delta T = 12.500 \text{ mm} \cdot 10.8 \cdot 10^{-6} \text{ 1/K} \cdot 10 \text{ K} = 1.35 \text{ } \mu\text{m}$$

##### Inner ring:

$$d_{i0} \approx (d+D)/2 - D_w = (4+16) \text{ mm}/2 - 2.50 \text{ mm} = 7.50 \text{ mm}$$

$$\Delta d_i \approx d_{i0} \cdot \alpha \cdot \Delta T = 7.50 \text{ mm} \cdot 10.8 \cdot 10^{-6} \text{ 1/K} \cdot 40 \text{ K} = 3.24 \text{ } \mu\text{m}$$

##### Ball:

$$D_w = 2.50 \text{ mm}$$

$$\Delta D_w \approx D_w \cdot \alpha \cdot \Delta T = 2.50 \text{ mm} \cdot 10.8 \cdot 10^{-6} \text{ 1/K} \cdot (10+40) \text{ K}/2 \approx 0.68 \text{ } \mu\text{m}$$

#### Change in radial clearance due to thermal expansion:

$$\Delta S_{RT} \approx \Delta d_a - \Delta d_i - 2\Delta D_w$$

$$\Delta S_{RT} \approx (1.35 - 3.24 - 2 \cdot 0.68) \text{ } \mu\text{m} = -3.25 \text{ } \mu\text{m}$$

The radial clearance is reduced due to the temperature difference between inner ring and outer ring by  $3.25 \text{ } \mu\text{m}$ .

#### Change in radial clearance due to interference fit:

##### Outer ring:

$$\text{Outside diameter: } 0/-8 \text{ } \mu\text{m}$$

$$\text{Housing diameter: } +2/-6 \text{ } \mu\text{m}$$

$$\rightarrow \ddot{u} = 6 \text{ } \mu\text{m}$$

$$\Delta S_{R\ddot{u}o} \approx k \cdot \ddot{u}$$

$$\Delta S_{R\ddot{u}o} \approx 0.8 \cdot 6 \text{ } \mu\text{m} = 4.8 \text{ } \mu\text{m}$$

##### Inner ring:

$$\text{Bore: } 0/-8 \text{ } \mu\text{m}$$

$$\text{Shaft: } +3/-2 \text{ } \mu\text{m}$$

$$\rightarrow \ddot{u} = 11 \text{ } \mu\text{m}$$

$$\Delta S_{R\ddot{u}i} \approx k \cdot \ddot{u}$$

$$\Delta S_{R\ddot{u}i} \approx 0.5 \cdot 11 \text{ } \mu\text{m} = 5.5 \text{ } \mu\text{m}$$

The radial clearance changes due to the interference fit by  $4.8 \text{ } \mu\text{m} + 5.5 \text{ } \mu\text{m} = 10.3 \text{ } \mu\text{m}$

#### Total change of radial clearance due to thermal expansion and interference fit:

$$\Delta S_R = \Delta S_{RT} + \Delta S_{R\ddot{u}} [\text{ } \mu\text{m}]$$

$$\Delta S_R = 3.25 \text{ } \mu\text{m} + 10.3 \text{ } \mu\text{m} = 13.55 \text{ } \mu\text{m}$$

This total reduction in radial clearance must be considered when selecting the radial clearance of the bearing.

## Radial play classification

### Radial play for deep groove radial bearing

#### d max 6 mm

C2	0 to 6 $\mu\text{m}$
CN	4 to 11 $\mu\text{m}$
C3	10 to 20 $\mu\text{m}$
C4	14 to 20 $\mu\text{m}$
C5	18 to 28 $\mu\text{m}$

#### d more than 6 to 10 mm

C2	0 to 6 $\mu\text{m}$
CN	4 to 11 $\mu\text{m}$
C3	10 to 20 $\mu\text{m}$
C4	14 to 29 $\mu\text{m}$
C5	20 to 37 $\mu\text{m}$

#### d more than 10 to 18 mm

C2	0 to 9 $\mu\text{m}$
CN	3 to 18 $\mu\text{m}$
C3	11 to 25 $\mu\text{m}$
C4	18 to 33 $\mu\text{m}$
C5	25 to 45 $\mu\text{m}$

#### d more than 18 to 24 mm

C2	0 to 10 $\mu\text{m}$
CN	5 to 20 $\mu\text{m}$
C3	13 to 28 $\mu\text{m}$
C4	20 to 36 $\mu\text{m}$
C5	28 to 48 $\mu\text{m}$

#### Deviating radial clearance data metric system

C1/5	1 to 5 $\mu\text{m}$
C4/8	4 to 8 $\mu\text{m}$
C7/11	7 to 11 $\mu\text{m}$
C10/15	10 to 15 $\mu\text{m}$

#### d more than 24 to 30 mm

C2	1 to 11 $\mu\text{m}$
CN	5 to 20 $\mu\text{m}$
C3	13 to 28 $\mu\text{m}$
C4	23 to 41 $\mu\text{m}$
C5	30 to 53 $\mu\text{m}$

#### d more than 30 to 40 mm

C2	1 to 11 $\mu\text{m}$
CN	6 to 20 $\mu\text{m}$
C3	15 to 33 $\mu\text{m}$
C4	28 to 46 $\mu\text{m}$
C5	40 to 64 $\mu\text{m}$

#### d more than 40 to 50 mm

C2	1 to 11 $\mu\text{m}$
CN	6 to 23 $\mu\text{m}$
C3	18 to 36 $\mu\text{m}$
C4	30 to 51 $\mu\text{m}$
C5	45 to 73 $\mu\text{m}$

#### Deviating radial clearance data inch system

K02	0" to .0002"
K13	.0001" to .0003"
K24	.0002" to .0004"
K35	.0003" to .0005"
K46	.0004" to .0006"
K58	.0005" to .0008"

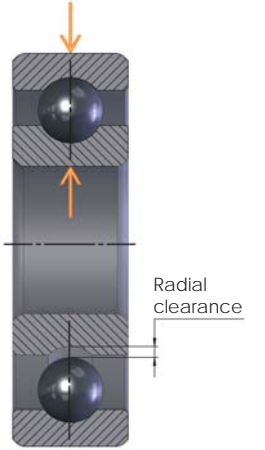

## Functional tests

There are different functional tests that can be performed by GRW. As a standard, 100% of our ball bearings are noise tested. Besides this standard testing, the following tests are available: axial vibration tests, torque test and preload measurement.

These tests ensure the uniformity of the production run and compliance with customer requirements. All functional tests carried out by GRW take place in a class R 10,000 cleanroom (ISO 14644-1, class 7).

The functional test method is always selected to simulate the intended use of the bearing.

### Noise test GPR

In the GRW numbering system GPR designates 100% noise testing. Using highly sensitive noise testing equipment, the amplitude of the vibrations generated by the miniature bearings is measured at specified speeds and frequencies. This method detects imperfections, such as ball or raceway defects and isolates their root cause.

This noise test is carried out in a class R10,000 cleanroom in accordance with ISO 14644-1, class 7. A standard reference oil is used to eliminate the variable effects of different lubricants.

### Axial vibration test GPA

GPA stands for noise testing in the axial direction. Similar to the GPR test, the axial vibrations measured by the GPA vibration meter identify the shape and surface properties of raceways and balls in the bearings.

GPA testing measures vibration noise in four distinct frequency ranges as compared to two frequency ranges for the GPR test. The amount of movement or 'peak to peak displacement' value is also recorded. The cumulative total of these distinct measurements provides a direct understanding of the ball bearing's running behavior.

As with the GPR test, standard reference oil is used to eliminate the variable effects of different lubricants.

The GPA test is offered at an additional charge. If you require any further information, please contact your GRW sales representative.

### Torque test

GRW uses different methods to measure starting and dynamic torque. The Asch testing device due to MIL-STD-206 provides very exact and reliable starting torque values. During this test the outer ring is driven and the inner ring is loaded relative to each bearing size. The standard axial loading of the inner ring is 75 g for ball bearings with an outer diameter of up to 10 mm. Ball bearings with a larger outer diameter (> 10 mm) are loaded with 400 g.

Since there is no universally accepted standard for torque measurement, the torques of identical bearings can only be compared if they have been measured under the same measuring conditions with the same measuring devices.

Table "maximum starting torque in  $\mu\text{Nm}$ " shows reference values for the maximum starting torque. These values apply for instrument ball bearings without seals, P5 or ABEC5 or better, which are lubricated with instrument oil having a low viscosity  $\leq 14 \text{ mm}^2/\text{s}$  at  $+40 \text{ }^\circ\text{C}$ . The values can be 10 to 40 times higher for ball bearings with grease lubrication.

Running or dynamic torque is the force required to keep a bearing in rotation. A special dynamic torque tester developed by GRW for this very purpose is available on request to measure the running torque at higher speeds.

### Maximum starting torque in $\mu\text{Nm}$

Basic symbol	Torque in [ $\mu\text{Nm}$ ]	Load in [g]	Basic symbol	Torque in [ $\mu\text{Nm}$ ]	Load in [g]	Basic symbol	Torque in [ $\mu\text{Nm}$ ]	Load in [g]
681	15	75	695	69	400	1016	15	75
691	15	75	605	69	400	1191	15	75
68/1,5	15	75	625	69	400	1397	15	75
69/1,5	15	75	635	76	400	5/64	15	75
682	15	75	686	69	400	2380	15	75
692	15	75	696	69	400	3/32	15	75
67/2,35	15	75	626	76	400	3175	15	75
68/2,35	15	75	687	69	400	1/8A	15	75
68/2,5	15	75	697	76	400	1/8B	16	75
69/2,5	15	75	607	76	400	3967	15	75
60/2,5	16	75	627	80	400	4763A	15	75
673	16	75	688A	52	400	4763B	16	75
683	16	75	688	76	400	3/16	52	400
693	16	75	698	76	400	6350A	15	75
623	16	75	608	80	400	6350B	52	400
674	16	75	689	76	400	1/4A	60	400
684	16	75	699	80	400	1/4	70	400
694	65	400	609	80	400	7938	52	400
604	65	400	629	100	400	3/8	95	400
624	69	400	6800	80	400			
634	69	400	6900	95	400			
675	65	400	6000	100	400			
685	65	400						

### Conversion table

	1 $\mu\text{Nm}$ =	1 cmp =	1 oz.in. =	1 cNcm =
$\mu\text{Nm}$	1	100	7200	100
cmp	0.01	1	72	1
oz.in.	0.000139	0.0139	1	0.0139
cNcm	0.01	1	72	1

### Assembly of low-torque ball bearings

Shaft and housing fits and tolerances for low-torque bearings are particularly important. Shaft and housing tolerances need to be selected so that they result in a sliding fit. Please refer to the chapters "Fitting Tolerances" and "Reduction in radial play".

Even a small misalignment of the inner or outer ring can result in an increased bearing torque. Particular attention must be given to the exact alignment between shaft and housing bore, as well as to the parallelism of the mating faces.

Extreme cleanliness of parts and assembly area is essential to produce a perfect low-torque bearing. Even the tiniest contaminations of the ball bearings can cause torque peaks, which may be many times higher than the average torque level.

### Preloading test

Another testing device specifically developed by GRW measures and records the preloading of duplexed bearings (following the "broken curve" method). This type of measurement is available on request.

# Tolerance and Runout Tables – inner ring

GRW bearings conform to the applicable ISO P0 to P2 (P2 = highest tolerance) and for inch size bearings according to ABEC quality standards ABEC1 to ABEC9 (ABEC9 = highest tolerance). For metric size bearings, tolerances comply with ISO quality

GRW manufactures miniature ball bearings according to the highest quality standards for both inch and metric sizes. GRW's sales engineers will be pleased to support you selecting the suitable quality for your application. Including tolerances of mating parts, such as shafts and housings, to create a bearing friendly environment.

Definition:	Diameter series	d [mm]		P0 [µm]		P6 [µm]		P5 [µm]		P4 [µm]		P2 [µm]		P5A <sup>(4)</sup> [µm]		P4A <sup>(4)</sup> [µm]		P4S <sup>(5)</sup> [µm]		ABEC1 [.0001 inch]		ABEC3 [.0001 inch]		ABEC5 [.0001 inch]		ABEC7 [.0001 inch]		ABEC9 [.0001 inch]		ABEC3P [.0001 inch]		ABEC5P [.0001 inch]		ABEC7P [.0001 inch]		ABEC9P [.0001 inch]		ABEC5T <sup>(6)</sup> [.0001 inch]		
		above	to	max.	min.	max.	min.	max.	min.	max.	min.	max.	min.	max.	min.	max.	min.	max.	min.	max.	min.	max.	min.	max.	min.	max.	min.	max.	min.	max.	min.	max.	min.	max.	min.	max.	min.	max.	min.	
single plane mean bore diameter deviation	Δdmp	0.6	18	0	-8	0	-7	0	-5	0	-4	0	-2.5	0	-5	0	-4	0	-4	0	-3	0	-3	0	-2	0	-1.5	0	-1	0	-2	0	-2	0	-2	0	-1	0	-2	
		18	30	0	-10	0	-8	0	-6	0	-5	0	-2.5	0	-6	0	-5	0	-5	0	-4	0	-3	0	-2.5	0	-2	0	-1	0	-2	0	-2	0	-2	0	-1	0	-2	
		30	50	0	-12	0	-10	0	-8	0	-6	0	-2.5							0	-4.5	0	-4	0	-3	0	-2.5	0	-1									0	-3	
Bore diameter variation in a single radial plane (out of roundness)	7/8/9	0.6	18	10		9		5		4		2.5		3		2.5		2.5																						
		18	30	13		10		6		5		2.5		3		2.5		2.5																						
		30	50	15		13		8		6		2.5																												
	0	0.6	18	8		7		4		3		2.5		3		2.5		2.5																						
		18	30	10		8		5		4		2.5		3		2.5		2.5																						
		30	50	12		10		6		5		2.5																												
2/3	0.6	18	6		5		4		3		2.5		3		2.5		2.5																							
	18	30	8		6		5		4		2.5		3		2.5		2.5																							
	30	50	9		8		6		5		2.5																													
Mean bore diameter variation (conicity)	Vdmp	0.6	18	6		5		3		2		1.5		3		2		1.5																						
		18	30	8		6		3		2.5		1.5		3		2.5		1.5																						
		30	50	9		8		4		3		1.5																												
Variation of a single inner ring width from nominal dimension	ΔBs <sup>(1)</sup>	0.6	2.5	0	-40	0	-40	0	-40	0	-40	0	-40	0	-25	0	-25	0	-100																					
		0.6	10																		0	-50	0	-50	0	-16	0	-16	0	-16	0	-50	0	-10	0	-10	0	-10	0	-10
		2.5	10	0	-120	0	-120	0	-40	0	-40	0	-40	0	-25	0	-25	0	-100		0	-50	0	-50	0	-32	0	-32	0	-32	0	-50	0	-10	0	-10	0	-10	0	-10
		10	18	0	-120	0	-120	0	-80	0	-80	0	-80	0	-25	0	-25	0	-100		0	-50	0	-50	0	-50	0	-50	0	-50	0	-50	0	-50	0	-10	0	-10	0	-10
		18	30	0	-120	0	-120	0	-120	0	-120	0	-120	0	-25	0	-25	0	-120		0	-50	0	-50	0	-50	0	-50	0	-50	0	-50	0	-50	0	-10	0	-10	0	-10
30	50	0	-120	0	-120	0	-120	0	-120	0	-120	0	-120	0	-120	0	-120		0	-50	0	-50	0	-50	0	-50	0	-50	0	-50	0	-50	0	-50	0	-50	0	-50		
Variation in the width of the inner ring	VBs	0.6	2.5	12		12		5		2.5		1.5																												
		0.6	10																		6		6		2		1		.5											
		2.5	10	15		15		5		2.5		1.5		5		2.5		1.5																						
		10	18	20		20		5		2.5		1.5		5		2.5		1.5																						
		18	30	20		20		5		2.5		1.5		5		2.5		1.5																						
30	50	20		20		5		3		1.5																														
Radial runout of the inner ring of the assembled bearing (dynamic imbalance)	Kia	0.6	2.5	10		5		4		2.5		1.5		3.5		2.5		1.5																						
		2.5	10	10		6		4		2.5		1.5		3.5		2.5		1.5																						
		10	18	10		7		4		2.5		1.5		3.5		2.5		1.5																						
		18	30	13		8		4		3		2.5		3.5		3		2.5																						
		30	50	15		10		5		4		2.5																												
Face runout with bore (lateral runout)	Sd	0.6	18					7		3		1.5		7		3		1.5																						
		18	30					8		4		1.5		8		4		1.5																						
		30	50					8		4		1.5																												
Assembled bearing inner ring face runout with raceway (axial runout)	Sia	0.6	18					7		3		1.5		7		3		1.5																						
		18	30					8		4		2.5		8		4		2.5																						
		30	50					8		4		2.5																												

Subject to change.

<sup>(1)</sup> Tolerance for matched bearings is 0/-200 µm

<sup>(2)</sup> Applicable before assembly of the bearing and after removal of the inner and/ or outer circlips

<sup>(3)</sup> For flanged bearings inboard side of the flange

<sup>(4)</sup> For deep groove radial bearings only

<sup>(5)</sup> For spindle bearings only

<sup>(6)</sup> Nominal value for bores of 9 mm and up





# Deep groove radial ball bearings – metric

GRW-designation	Main dimensions in [mm] [inch]		Bearing without closure in [mm] [inch]				Bearing with closure in [mm] [inch]				Chamfer in [mm] [inch]	Mounting dimensions acc. to DIN 5418 [mm] [inch]		Load ratings acc. to DIN ISO <sup>(2)</sup> (max)		Closure options <sup>(3)</sup>		Max. limiting speed <sup>(5)</sup> [mm <sup>-1</sup> ]	
	d	D	Width without closure	Width with extended inner ring without closure	Flange dimensions without closure		Width with closure	Width with extended inner ring with closure	Flange dimensions with closure			r <sub>s min</sub> <sup>(1)</sup>	Shaft diameter	Housing diameter	C <sub>r</sub> [N]	C <sub>0r</sub> [N]	Shield <sup>(4)</sup>	Seal <sup>(4)</sup>	without closure or with shield
Basic symbol			B	B <sub>1</sub>	Flange diameter FD	Flange width FB	B <sub>2</sub>	B <sub>3</sub>	Flange diameter FD <sub>1</sub>	Flange width FB <sub>1</sub>		d <sub>a min</sub>	D <sub>a max</sub>						
67/0,6	<b>0.60</b> .0236	<b>2.00</b> .0787	<b>0.80</b> .0315	-	-	-	-	-	-	-	<b>0.05</b> .002	<b>1.00</b> .039	<b>1.60</b> .063	27	7	-	-	170000	-
68/1,5/0003	<b>0.80</b> .0315	<b>4.00</b> .1575	<b>2.00</b> .0787	-	<b>5.00</b> .1969	<b>0.60</b> .0236	<b>2.00</b> .0787	-	<b>5.00</b> .1969	<b>0.60</b> .0236	<b>0.05</b> .002	<b>1.20</b> .047	<b>3.60</b> .142	163	44	X	-	138000	-
681	<b>1.00</b> .0394	<b>3.00</b> .1181	<b>1.00</b> .0394	-	-	-	<b>2.00</b> .0787	-	-	-	<b>0.05</b> .002	<b>1.40</b> .055	<b>2.60</b> .102	82	22	X	-	150000	-
681/003	<b>1.00</b> .0394	<b>3.00</b> .1181	<b>2.00</b> .0787	-	-	-	<b>2.00</b> .0787	-	-	-	<b>0.05</b> .002	<b>1.40</b> .055	<b>2.60</b> .102	52	21	X	-	170000	-
691	<b>1.00</b> .0394	<b>4.00</b> .1575	<b>1.60</b> .0630	-	-	-	<b>2.30</b> .0906	-	-	-	<b>0.10</b> .004	<b>1.60</b> .063	<b>3.40</b> .130	160	43	-	-	126000	-
68/1,5/0001	<b>1.00</b> .0394	<b>4.00</b> .1575	-	-	-	-	<b>2.00</b> .0787	-	<b>5.00</b> .1969	<b>0.60</b> .0236	<b>0.05</b> .002	<b>1.40</b> .055	<b>3.60</b> .142	163	44	X	-	130000	-
68/1,5/0011	<b>1.00</b> .0394	<b>4.00</b> .1575	<b>2.00</b> .0787	-	<b>5.00</b> .1969	<b>0.60</b> .0236	<b>2.00</b> .0787	-	-	-	<b>0.05</b> .002	<b>1.40</b> .055	<b>3.60</b> .142	163	44	X	-	130000	-
68/1,5	<b>1.50</b> .0591	<b>4.00</b> .1575	<b>1.20</b> .0472	<b>2.00</b> .0787	<b>5.00</b> .1969	<b>0.40</b> .0157	<b>2.00</b> .0787	-	<b>5.00</b> .1969	<b>0.60</b> .0236	<b>0.05</b> .002	<b>1.90</b> .075	<b>3.60</b> .142	163	44	X	-	153000	-
68/1,5A	<b>1.50</b> .0591	<b>4.00</b> .1575	-	-	-	-	<b>2.00</b> .0787	-	<b>5.00</b> .1969	<b>0.60</b> .0236	<b>0.05</b> .002	<b>2.10</b> .083	<b>3.60</b> .142	112	33	X	-	120000	-
69/1,5 <sup>(4)</sup>	<b>1.50</b> .0591	<b>5.00</b> .1969	<b>2.00</b> .0787	<b>2.80</b> .1102	<b>6.50</b> .2559	<b>0.60</b> .0236	<b>2.60</b> .1024	<b>3.40</b> .130	<b>6.50</b> .2559	<b>0.80</b> .0315	<b>0.15</b> .006	<b>2.30</b> .091	<b>4.20</b> .165	192	59	X	-	109000	-
69/1,5/002	<b>1.50</b> .0591	<b>5.00</b> .1969	-	-	-	-	<b>2.00</b> .0787	-	<b>6.50</b> .2559	<b>0.60</b> .0236	<b>0.15</b> .006	<b>2.30</b> .091	<b>4.20</b> .165	192	59	X	-	93000	-
60/1,5	<b>1.50</b> .0591	<b>6.00</b> .2362	<b>2.50</b> .0984	-	<b>7.50</b> .2953	<b>0.60</b> .0236	<b>3.00</b> .1181	-	<b>7.50</b> .2953	<b>0.80</b> .0315	<b>0.15</b> .006	<b>2.30</b> .091	<b>5.20</b> .205	330	98	X	-	90000	-
672	<b>2.00</b> .0787	<b>4.00</b> .1575	<b>1.20</b> .0472	-	-	-	<b>2.00</b> .0787	-	-	-	<b>0.05</b> .002	<b>2.40</b> .094	<b>3.60</b> .142	124	40	X	-	104000	-
682	<b>2.00</b> .0787	<b>5.00</b> .1969	<b>1.50</b> .0591	<b>2.30</b> .0906	<b>6.10</b> .2402	<b>0.50</b> .0197	<b>2.30</b> .0906	<b>3.10</b> .122	<b>6.10</b> .2402	<b>0.60</b> .0236	<b>0.08</b> .003	<b>2.50</b> .098	<b>4.50</b> .177	192	59	X	X	116000	71000
682/003	<b>2.00</b> .0787	<b>5.00</b> .1969	-	-	-	-	<b>2.50</b> .0984	-	<b>6.20</b> .2441	<b>0.60</b> .0236	<b>0.10</b> .004	<b>2.60</b> .102	<b>4.40</b> .173	169	50	X	-	100000	-
682/005	<b>2.00</b> .0787	<b>5.00</b> .1969	<b>2.60</b> .1024	-	<b>6.50</b> .2559	<b>0.80</b> .0315	<b>2.60</b> .1024	-	<b>6.50</b> .2559	<b>0.80</b> .0315	<b>0.08</b> .003	<b>2.50</b> .098	<b>4.50</b> .177	192	59	X	-	105000	-
692/003	<b>2.00</b> .0787	<b>6.00</b> .2362	<b>2.00</b> .0787	-	-	-	-	-	-	-	<b>0.15</b> .006	<b>2.80</b> .110	<b>5.20</b> .205	286	90	-	-	91000	-
692	<b>2.00</b> .0787	<b>6.00</b> .2362	<b>2.30</b> .0906	<b>3.10</b> .1220	<b>7.50</b> .2953	<b>0.60</b> .0236	<b>2.30</b> .0906	<b>3.10</b> .122	<b>7.50</b> .2953	<b>0.60</b> .0236	<b>0.15</b> .006	<b>2.80</b> .110	<b>5.20</b> .205	286	90	X	X	91000	65000

Note:

<sup>(1)</sup> r<sub>s min</sub> = minimum single bearing chamfer or maximum permissible shaft or housing fillet radius

<sup>(2)</sup> Other load ratings are possible with different ball complements and non standard retainers

<sup>(3)</sup> Different shields and seals are available

<sup>(4)</sup> Bearings also available with 1 or 2 shields/seals

<sup>(5)</sup> Limiting speed also depends on seal, material and the respective ball complement

• Bearings without shields or retainers are also available with recesses.

• Please discuss your desired design in terms of flange, extended inner ring width, shield, lubrication, and material with our Technical Application Consultants to check availability.

• Subject to change.

• Almost all bearing types can also be enhanced with GRW XTRA. Detailed information you can find on page 79 and following.

# Deep groove radial ball bearings – metric

GRW-designation	Main dimensions in [mm] [inch]		Bearing without closure in [mm] [inch]				Bearing with closure in [mm] [inch]				Chamfer in [mm] [inch]	Mounting dimensions acc. to DIN 5418 [mm] [inch]		Load ratings acc. to DIN ISO <sup>(2)</sup> (max)		Closure options <sup>(3)</sup>		Max. limiting speed <sup>(5)</sup> [mm <sup>-1</sup> ]	
	d	D	Width without closure	Width with extended inner ring without closure	Flange dimensions without closure		Width with closure	Width with extended inner ring with closure	Flange dimensions with closure			r <sub>s min</sub> <sup>(1)</sup>	Shaft diameter	Housing diameter	C <sub>r</sub> [N]	C <sub>0r</sub> [N]	Shield <sup>(4)</sup>	Seal <sup>(4)</sup>	without closure or with shield
Basic symbol			B	B <sub>1</sub>	Flange diameter FD	Flange width FB	B <sub>2</sub>	B <sub>3</sub>	Flange diameter FD <sub>1</sub>	Flange width FB <sub>1</sub>		d <sub>a min</sub>	D <sub>a max</sub>						
692/005	<b>2.00</b> .0787	<b>6.00</b> .2362	<b>2.50</b> .0984	–	<b>7.20</b> .2835	<b>0.60</b> .0236	<b>2.50</b> .0984	–	–	–	<b>0.15</b> .006	<b>2.80</b> .110	<b>5.20</b> .205	330	99	X	–	90000	–
692/004	<b>2.00</b> .0787	<b>6.00</b> .2362	<b>3.00</b> .1181	–	<b>7.50</b> .2953	<b>0.80</b> .0315	<b>3.00</b> .1181	–	<b>7.50</b> .2953	<b>0.80</b> .0315	<b>0.15</b> .006	<b>2.80</b> .110	<b>5.20</b> .205	330	99	X	–	95000	–
683/0003	<b>2.00</b> .0787	<b>7.00</b> .2756	<b>3.00</b> .1181	–	<b>8.20</b> .3228	<b>0.60</b> .0236	<b>3.00</b> .1181	–	<b>8.20</b> .3228	<b>0.60</b> .0236	<b>0.15</b> .006	<b>2.80</b> .110	<b>6.20</b> .244	386	129	X	–	75000	–
693/0001	<b>2.00</b> .0787	<b>8.00</b> .3150	<b>4.00</b> .1575	–	<b>9.50</b> .3740	<b>0.90</b> .0354	<b>4.00</b> .1575	–	<b>9.50</b> .3740	<b>0.90</b> .0354	<b>0.15</b> .006	<b>2.80</b> .150	<b>7.20</b> .283	644	215	X	–	67000	–
67/2,35 <sup>(6)</sup>	<b>2.35</b> .0925	<b>5.00</b> .1969	<b>1.50</b> .0591	<b>2.30</b> .0906	<b>6.10</b> .2402	<b>0.50</b> .0197	<b>2.30</b> .0906	–	<b>6.10</b> .2402	<b>0.60</b> .0236	<b>0.08</b> .003	<b>2.50</b> .098	<b>4.50</b> .177	192	59	X	–	120000	–
68/2,35 <sup>(6)</sup>	<b>2.35</b> .0925	<b>5.50</b> .2165	<b>2.00</b> .0787	–	–	–	–	–	–	–	<b>0.08</b> .003	<b>2.90</b> .114	<b>5.00</b> .197	286	90	–	–	91000	–
67/2,5	<b>2.50</b> .0984	<b>5.00</b> .1969	<b>1.50</b> .0591	–	–	–	–	–	–	–	<b>0.08</b> .003	<b>2.90</b> .114	<b>4.60</b> .181	192	59	–	–	93000	–
68/2,5	<b>2.50</b> .0984	<b>6.00</b> .2362	<b>1.80</b> .0709	<b>2.60</b> .1024	<b>7.10</b> .2795	<b>0.50</b> .0197	<b>2.60</b> .1024	<b>3.40</b> .1303	<b>7.10</b> .2795	<b>0.80</b> .0315	<b>0.08</b> .003	<b>3.00</b> .118	<b>5.50</b> .217	286	90	X	X	101000	61000
69/2,5/002	<b>2.50</b> .0984	<b>7.00</b> .2756	–	–	–	–	<b>2.50</b> .0984	–	–	–	<b>0.10</b> .004	<b>3.10</b> .122	<b>6.40</b> .252	177	58	X	–	75000	–
69/2,5	<b>2.50</b> .0984	<b>7.00</b> .2756	<b>2.50</b> .0984	–	<b>8.50</b> .3346	<b>0.70</b> .0276	<b>3.50</b> .1307	–	<b>8.50</b> .3346	<b>0.90</b> .0354	<b>0.15</b> .006	<b>3.30</b> .130	<b>6.30</b> .248	432	149	X	X	87000	53000
683/0001	<b>2.50</b> .0984	<b>7.00</b> .2756	<b>2.00</b> .0787	–	<b>8.10</b> .3189	<b>0.50</b> .0197	<b>3.00</b> .1181	–	<b>8.10</b> .3189	<b>0.80</b> .0315	<b>0.10</b> .004	<b>3.60</b> .142	<b>6.40</b> .252	432	149	X	–	88000	–
60/2,5	<b>2.50</b> .0984	<b>8.00</b> .3150	<b>2.80</b> .1102	<b>3.60</b> .1417	<b>9.50</b> .3740	<b>0.70</b> .0276	<b>2.80</b> .1102	<b>3.60</b> .1417	<b>9.50</b> .3740	<b>0.70</b> .0276	<b>0.15</b> .006	<b>3.30</b> .130	<b>7.20</b> .283	432	149	X	X	81000	53000
60/2,5/004	<b>2.50</b> .0984	<b>8.00</b> .3150	<b>4.00</b> .1575	–	<b>9.50</b> .3740	<b>0.90</b> .0354	<b>4.00</b> .1575	–	<b>9.50</b> .3740	<b>0.90</b> .0354	<b>0.15</b> .006	<b>3.30</b> .130	<b>7.20</b> .283	552	177	X	–	71000	–
673	<b>3.00</b> .1181	<b>6.00</b> .2362	<b>2.00</b> .0787	–	<b>7.20</b> .2835	<b>0.60</b> .0236	<b>2.00</b> .0787	–	–	–	<b>0.08</b> .003	<b>3.60</b> .142	<b>5.40</b> .213	208	74	x	–	81000	–
673/003	<b>3.00</b> .1181	<b>6.00</b> .2362	–	–	–	–	<b>2.50</b> .0984	–	<b>7.20</b> .2835	<b>0.60</b> .0236	<b>0.10</b> .004	<b>3.60</b> .142	<b>5.40</b> .213	208	74	X	–	80000	–
683/63	<b>3.00</b> .1181	<b>7.00</b> .2751	–	–	–	–	<b>3.00</b> .1181	<b>3.80</b> .1496	–	–	<b>0.10</b> .004	<b>3.60</b> .142	<b>7.40</b> .291	432	149	X	X	80000	50000
683	<b>3.00</b> .1181	<b>7.00</b> .2756	<b>2.00</b> .0787	<b>2.80</b> .1102	<b>8.10</b> .3189	<b>0.50</b> .0197	<b>3.00</b> .1181	<b>3.80</b> .1496	<b>8.10</b> .3189	<b>0.80</b> .0315	<b>0.10</b> .004	<b>3.60</b> .142	<b>6.40</b> .252	432	149	X	X	90000	53000
683/8	<b>3.00</b> .1181	<b>8.00</b> .3150	<b>3.00</b> .1181	–	–	–	<b>3.00</b> .1181	<b>3.80</b> .1496	–	–	<b>0.10</b> .004	<b>3.60</b> .142	<b>7.40</b> .291	432	149	X	X	95000	55000

Note:  
<sup>(1)</sup> r<sub>s min</sub> = minimum single bearing chamfer or maximum permissible shaft or housing fillet radius  
<sup>(2)</sup> Other load ratings are possible with different ball complements and non standard retainers  
<sup>(3)</sup> Different shields and seals are available  
<sup>(4)</sup> Bearings also available with 1 or 2 shields/seals  
<sup>(5)</sup> Limiting speed also depends on seal, material and the respective ball complement  
<sup>(6)</sup> Tolerance of bore +12µm to 3µm

• Bearings without shields or retainers are also available with recesses.  
 • Please discuss your desired design in terms of flange, extended inner ring width, shield, lubrication, and material with our Technical Application Consultants to check availability.  
 • Subject to change.  
 • Almost all bearing types can also be enhanced with GRW XTRA. Detailed information you can find on page 79 and following.

# Deep groove radial ball bearings – metric

GRW-designation	Main dimensions in [mm] [inch]		Bearing without closure in [mm] [inch]				Bearing with closure in [mm] [inch]				Chamfer in [mm] [inch]	Mounting dimensions acc. to DIN 5418 [mm] [inch]		Load ratings acc. to DIN ISO <sup>(2)</sup> (max)		Closure options <sup>(3)</sup>		Max. limiting speed <sup>(5)</sup> [mm <sup>-1</sup> ]	
	d	D	Width without closure	Width with extended inner ring without closure	Flange dimensions without closure		Width with closure	Width with extended inner ring with closure	Flange dimensions with closure			r <sub>s min</sub> <sup>(1)</sup>	Shaft diameter	Housing diameter	C <sub>r</sub> [N]	C <sub>0r</sub> [N]	Shield <sup>(4)</sup>	Seal <sup>(4)</sup>	without closure or with shield
Basic symbol			B	B <sub>1</sub>	Flange diameter FD	Flange width FB	B <sub>2</sub>	B <sub>3</sub>	Flange diameter FD <sub>1</sub>	Flange width FB <sub>1</sub>		d <sub>a min</sub>	D <sub>a max</sub>						
683/003	<b>3.00</b> .1181	<b>7.00</b> .2756	<b>2.50</b> .0984	-	-	-	<b>2.50</b> .0984	-	-	-	<b>0.10</b> .004	<b>3.60</b> .142	<b>6.40</b> .252	432	149	X	-	93000	-
693/003	<b>3.00</b> .1181	<b>8.00</b> .3150	<b>2.50</b> .0984	-	-	-	-	-	-	-	<b>0.15</b> .006	<b>3.80</b> .150	<b>7.20</b> .283	644	215	-	-	60000	-
693 <sup>(4)</sup>	<b>3.00</b> .1181	<b>8.00</b> .3150	<b>3.00</b> .1181	<b>3.80</b> .1496	<b>9.50</b> .3740	<b>0.70</b> .0276	<b>4.00</b> .1575	<b>4.80</b> .1890	<b>9.50</b> .3740	<b>0.90</b> .0354	<b>0.15</b> .006	<b>3.80</b> .150	<b>7.20</b> .283	644	215	X	X	80000	51000
693/002	<b>3.00</b> .1181	<b>8.00</b> .3150	-	-	<b>9.50</b> .3740	<b>0.70</b> .0276	<b>3.00</b> .1181	-	<b>9.50</b> .3740	<b>0.70</b> .0276	<b>0.15</b> .006	<b>3.80</b> .150	<b>7.20</b> .283	395	141	X	-	67000	-
603	<b>3.00</b> .1181	<b>9.00</b> .3543	<b>3.00</b> .1181	-	<b>10.50</b> .4134	<b>0.70</b> .0276	<b>5.00</b> .1969	-	<b>10.50</b> .4134	<b>1.00</b> .0394	<b>0.15</b> .006	<b>3.80</b> .150	<b>8.20</b> .323	571	189	X	-	67000	-
603/003	<b>3.00</b> .1181	<b>9.00</b> .3543	-	-	-	-	<b>4.00</b> .1575	-	<b>10.60</b> .4173	<b>0.80</b> .0315	<b>0.20</b> .008	<b>4.40</b> .173	<b>7.60</b> .299	571	189	X	-	67000	-
603/004	<b>3.00</b> .1181	<b>9.00</b> .3543	<b>2.50</b> .0984	-	<b>10.20</b> .4016	<b>0.60</b> .0236	-	-	-	-	<b>0.20</b> .008	<b>4.40</b> .173	<b>7.60</b> .299	571	189	-	-	67000	-
623	<b>3.00</b> .1181	<b>10.00</b> .3937	<b>4.00</b> .1575	<b>4.80</b> .1890	<b>11.50</b> .4528	<b>1.00</b> .0394	<b>4.00</b> .1575	<b>4.80</b> .1890	<b>11.50</b> .4528	<b>1.00</b> .0394	<b>0.15</b> .006	<b>4.40</b> .173	<b>8.60</b> .339	725	265	X	X	65000	44000
623/13	<b>3.00</b> .1181	<b>13.00</b> .5118	<b>4.00</b> .1575	<b>4.80</b> .1890	-	-	<b>4.00</b> .1575	<b>4.80</b> .1890	-	-	<b>0.15</b> .006	<b>4.40</b> .173	<b>8.60</b> .339	725	265	X	X	70000	46000
633	<b>3.00</b> .1181	<b>13.00</b> .5118	<b>5.00</b> .1969	-	<b>15.00</b> .5906	<b>1.00</b> .0394	<b>5.00</b> .1969	-	<b>15.00</b> .5906	<b>1.00</b> .0394	<b>0.20</b> .008	<b>4.80</b> .1890	<b>11.20</b> .441	1339	488	X	-	55000	-
693/0004	<b>3.30</b> .1299	<b>8.00</b> .3150	<b>4.00</b> .1575	-	<b>9.50</b> .3740	<b>0.90</b> .0354	<b>4.00</b> .1575	-	<b>9.50</b> .3740	<b>0.90</b> .0354	<b>0.15</b> .006	<b>4.10</b> .161	<b>7.20</b> .283	625	213	X	-	80000	-
674/004	<b>4.00</b> .1575	<b>7.00</b> .2756	<b>1.60</b> .0630	-	-	-	<b>1.60</b> .063	-	-	-	<b>0.08</b> .003	<b>4.50</b> .177	<b>6.50</b> .256	337	129	-	-	60000	-
674	<b>4.00</b> .1575	<b>7.00</b> .2756	<b>2.00</b> .0787	-	-	-	<b>2.00</b> .0787	-	-	-	<b>0.08</b> .003	<b>4.50</b> .177	<b>6.50</b> .256	345	130	X	-	67000	-
674/003	<b>4.00</b> .1575	<b>7.00</b> .2756	<b>2.50</b> .0984	-	-	-	<b>2.50</b> .0984	-	<b>8.20</b> .3228	<b>0.60</b> .0236	<b>0.08</b> .003	<b>4.50</b> .177	<b>6.50</b> .256	255	108	X	-	67000	-
693B/0021	<b>4.00</b> .1575	<b>8.00</b> .3150	<b>3.00</b> .1181	-	-	-	<b>3.00</b> .1181	-	-	-	<b>0.15</b> .006	<b>4.80</b> .189	<b>7.20</b> .283	380	127	X	-	72000	-
684	<b>4.00</b> .1575	<b>9.00</b> .3543	<b>2.50</b> .0984	<b>3.30</b> .1299	<b>10.30</b> .4055	<b>0.60</b> .0236	<b>4.00</b> .1575	<b>4.80</b> .1890	<b>10.30</b> .4055	<b>1.00</b> .0394	<b>0.10</b> .004	<b>4.60</b> .181	<b>8.40</b> .331	658	226	X	X	62000	45000
684/103	<b>4.00</b> .1575	<b>10.00</b> .3937	<b>3.00</b> .1181	-	<b>11.50</b> .4528	<b>0.80</b> .0315	-	-	-	-	<b>0.10</b> .004	<b>4.60</b> .181	<b>9.40</b> .370	658	226	-	-	48000	-
684/103	<b>4.00</b> .1575	<b>10.00</b> .3937	<b>3.00</b> .1181	-	<b>11.20</b> .4409	<b>0.60</b> .0236	-	-	-	-	<b>0.15</b> .006	<b>4.80</b> .189	<b>9.20</b> .362	711	272	-	-	56000	-

Note:

<sup>(1)</sup> r<sub>s min</sub> = minimum single bearing chamfer or maximum permissible shaft or housing fillet radius

<sup>(2)</sup> Other load ratings are possible with different ball complements and non standard retainers

<sup>(3)</sup> Different shields and seals are available

<sup>(4)</sup> Bearings also available with 1 or 2 shields/seals

<sup>(5)</sup> Limiting speed also depends on seal, material and the respective ball complement

• Bearings without shields or retainers are also available with recesses.

• Please discuss your desired design in terms of flange, extended inner ring width, shield, lubrication, and material with our Technical Application Consultants to check availability.

• Subject to change.

• Almost all bearing types can also be enhanced with GRW XTRA. Detailed information you can find on page 79 and following.

# Deep groove radial ball bearings – metric

GRW-designation	Main dimensions in [mm] [inch]		Bearing without closure in [mm] [inch]				Bearing with closure in [mm] [inch]				Chamfer in [mm] [inch]	Mounting dimensions acc. to DIN 5418 [mm] [inch]		Load ratings acc. to DIN ISO <sup>(2)</sup> (max)		Closure options <sup>(3)</sup>		Max. limiting speed <sup>(5)</sup> [mm <sup>-1</sup> ]	
	d	D	Width without closure	Width with extended inner ring without closure	Flange dimensions without closure		Width with closure	Width with extended inner ring with closure	Flange dimensions with closure			r <sub>s min</sub> <sup>(1)</sup>	Shaft diameter	Housing diameter	C <sub>r</sub> [N]	C <sub>0r</sub> [N]	Shield <sup>(4)</sup>	Seal <sup>(4)</sup>	without closure or with shield
Basic symbol	d	D	B	B <sub>1</sub>	Flange diameter FD	Flange width FB	B <sub>2</sub>	B <sub>3</sub>	Flange diameter FD <sub>1</sub>	Flange width FB <sub>1</sub>		d <sub>a min</sub>	D <sub>a max</sub>						
684/10	<b>4.00</b> .1575	<b>10.00</b> .3937	<b>4.00</b> .1575	<b>4.80</b> .1890	<b>11.50</b> .4528	<b>1.00</b> .0394	<b>4.00</b> .1575	<b>4.80</b> .1890	<b>11.50</b> .4528	<b>1.00</b> .0394	<b>0.10</b> .004	<b>4.60</b> .181	<b>9.40</b> .370	711	272	X	X	86000	45000
684/10 W8	<b>4.00</b> .1575	<b>10.00</b> .3937	-	-	-	-	<b>4.00</b> .1575	-	<b>11.60</b> .4567	<b>0.80</b> .0315	<b>0.15</b> .006	<b>4.80</b> .189	<b>9.20</b> .362	711	272	X	-	56000	-
694	<b>4.00</b> .1575	<b>11.00</b> .4331	<b>4.00</b> .1575	-	<b>12.50</b> .4921	<b>1.00</b> .0394	<b>4.00</b> .1575	-	<b>12.50</b> .4921	<b>1.00</b> .0394	<b>0.15</b> .006	<b>4.80</b> .189	<b>10.20</b> .402	730	271	X	X	66000	41000
604	<b>4.00</b> .1575	<b>12.00</b> .4724	<b>4.00</b> .1575	-	<b>13.50</b> .5315	<b>1.00</b> .0394	<b>4.00</b> .1575	-	<b>13.50</b> .5315	<b>1.00</b> .0394	<b>0.20</b> .008	<b>5.40</b> .213	<b>10.60</b> .417	734	282	X	X	56000	37000
624	<b>4.00</b> .1575	<b>13.00</b> .5118	<b>5.00</b> .1969	<b>5.80</b> .2283	<b>15.00</b> .5906	<b>1.00</b> .0394	<b>5.00</b> .1969	<b>5.80</b> .2283	<b>15.00</b> .5906	<b>1.00</b> .0394	<b>0.20</b> .008	<b>5.80</b> .228	<b>11.20</b> .441	1.339	488	X	X	52000	28000
694/133	<b>4.00</b> .1575	<b>13.00</b> .5118	<b>5.00</b> .1969	-	-	-	<b>5.00</b> .1969	-	-	-	<b>0.15</b> .006	<b>4.80</b> .189	<b>12.20</b> .480	730	271	X	X	65000	53000
624/16	<b>4.00</b> .1575	<b>16.00</b> .6299	<b>5.00</b> .1969	<b>5.80</b> .2283	-	-	<b>5.00</b> .1969	<b>5.80</b> .2283	-	-	<b>0.20</b> .008	<b>5.80</b> .228	<b>12.20</b> .480	1306	486	X	X	55000	30000
634	<b>4.00</b> .1575	<b>16.00</b> .6299	<b>5.00</b> .1969	-	<b>18.00</b> .7087	<b>1.00</b> .0394	<b>5.00</b> .1969	-	<b>18.00</b> .7087	<b>1.00</b> .0394	<b>0.30</b> .012	<b>6.40</b> .252	<b>13.60</b> .535	1730	670	X	X	44000	43000
624/17	<b>4.00</b> .1575	<b>17.00</b> .6693	<b>5.00</b> .1969	<b>5.80</b> .2283	-	-	<b>5.00</b> .1969	<b>5.80</b> .2283	-	-	<b>0.20</b> .008	<b>5.80</b> .228	<b>15.20</b> .598	1306	486	X	X	55000	30000
675	<b>5.00</b> .1969	<b>8.00</b> .3150	<b>2.00</b> .0787	-	-	-	<b>2.00</b> .0787	-	-	-	<b>0.08</b> .003	<b>5.50</b> .217	<b>7.50</b> .295	390	160	X	-	52000	-
675/003	<b>5.00</b> .1969	<b>8.00</b> .3150	<b>2.50</b> .0984	-	<b>9.20</b> .3622	<b>0.60</b> .0236	<b>2.50</b> .0984	-	-	-	<b>0.10</b> .004	<b>5.60</b> .220	<b>7.50</b> .295	218	90	X	-	63000	-
675/004	<b>5.00</b> .1969	<b>8.00</b> .3150	<b>3.00</b> .1181	-	-	-	<b>3.00</b> .1181	-	-	-	<b>0.08</b> .003	<b>5.40</b> .213	<b>7.60</b> .299	390	160	X	-	52000	-
675/094	<b>5.00</b> .1969	<b>9.00</b> .3543	<b>3.00</b> .1181	-	-	-	<b>3.00</b> .1181	-	<b>10.20</b> .4016	<b>0.60</b> .0236	<b>0.15</b> .006	<b>5.40</b> .213	<b>8.60</b> .339	431	169	X	-	60000	-
694A/1002	<b>5.00</b> .1969	<b>10.00</b> .3937	<b>4.00</b> .1575	-	-	-	<b>4.00</b> .1575	-	<b>11.20</b> .4409	<b>0.80</b> .0315	<b>0.15</b> .006	<b>5.50</b> .217	<b>8.80</b> .346	431	169	X	-	60000	-
694/1002	<b>5.00</b> .1969	<b>10.00</b> .3937	<b>4.00</b> .1575	-	-	-	<b>4.00</b> .1575	-	-	-	<b>0.15</b> .006	<b>5.50</b> .217	<b>8.80</b> .346	730	271	X	-	66000	-
694/1002 W1	<b>5.00</b> .1969	<b>10.00</b> .3937	<b>4.00</b> .1575	-	<b>11.60</b> .4567	<b>0.80</b> .0315	<b>4.00</b> .1575	-	<b>11.60</b> .4567	<b>0.80</b> .0315	<b>0.15</b> .006	<b>5.80</b> .228	<b>9.20</b> .362	431	169	X	-	60000	-
685	<b>5.00</b> .1969	<b>11.00</b> .4331	<b>3.00</b> .1181	-	<b>12.50</b> .4921	<b>0.80</b> .0315	<b>5.00</b> .1969	-	<b>12.50</b> .4921	<b>1.00</b> .0394	<b>0.15</b> .006	<b>5.80</b> .228	<b>10.70</b> .421	734	282	X	X	71000	37000
685/003	<b>5.00</b> .1969	<b>11.00</b> .4331	<b>4.00</b> .1575	-	<b>12.50</b> .4921	<b>1.00</b> .0394	<b>4.00</b> .1575	-	<b>12.50</b> .4921	<b>1.00</b> .0394	<b>0.15</b> .006	<b>5.80</b> .228	<b>10.70</b> .421	734	282	X	-	62000	-

Note:

<sup>(1)</sup> r<sub>s min</sub> = minimum single bearing chamfer or maximum permissible shaft or housing fillet radius

<sup>(2)</sup> Other load ratings are possible with different ball complements and non standard retainers

<sup>(3)</sup> Different shields and seals are available

<sup>(4)</sup> Bearings also available with 1 or 2 shields/seals

<sup>(5)</sup> Limiting speed also depends on seal, material and the respective ball complement

• Bearings without shields or retainers are also available with recesses.

• Please discuss your desired design in terms of flange, extended inner ring width, shield, lubrication, and material with our Technical Application Consultants to check availability.

• Subject to change.

• Almost all bearing types can also be enhanced with GRW XTRA. Detailed information you can find on page 79 and following.

# Deep groove radial ball bearings – metric

GRW-designation	Main dimensions in [mm] [inch]		Bearing without closure in [mm] [inch]				Bearing with closure in [mm] [inch]				Chamfer in [mm] [inch]	Mounting dimensions acc. to DIN 5418 [mm] [inch]		Load ratings acc. to DIN ISO <sup>(2)</sup> (max)		Closure options <sup>(3)</sup>		Max. limiting speed <sup>(5)</sup> [mm <sup>-1</sup> ]	
	d	D	Width without closure	Width with extended inner ring without closure	Flange dimensions without closure		Width with closure	Width with extended inner ring with closure	Flange dimensions with closure			r <sub>s min</sub> <sup>(1)</sup>	Shaft diameter	Housing diameter	C <sub>r</sub> [N]	C <sub>0r</sub> [N]	Shield <sup>(4)</sup>	Seal <sup>(4)</sup>	without closure or with shield
Basic symbol			B	B <sub>1</sub>	Flange diameter FD	Flange width FB	B <sub>2</sub>	B <sub>3</sub>	Flange diameter FD <sub>1</sub>	Flange width FB <sub>1</sub>		d <sub>a min</sub>	D <sub>a max</sub>						
695	5.00 .1969	13.00 .5118	4.00 .1575	-	15.00 .5906	1.00 .0394	4.00 .1575	-	15.00 .5906	1.00 .0394	0.20 .008	6.40 .252	11.60 .457	1077	432	X	X	50000	34000
624/0003	5.00 .1969	13.00 .5118	5.00 .1969	-	-	-	5.00 .1969	-	15.00 .5906	1.00 .0394	0.20 .008	6.80 .268	11.20 .441	1306	486	X	-	52000	-
605	5.00 .1969	14.00 .5512	5.00 .1969	-	16.00 .6299	1.00 .0394	5.00 .1969	-	16.00 .6299	1.00 .0394	0.20 .008	6.40 .252	12.60 .496	1329	507	X	X	50000	33000
625	5.00 .1969	16.00 .6299	5.00 .1969	5.80 .2283	18.00 .7087	1.00 .0394	5.00 .1969	5.80 .2283	18.00 .7087	1.00 .0394	0.30 .012	7.40 .291	13.60 .535	1729	675	X	X	50000	31000
635	5.00 .1969	19.00 .7480	6.00 .2362	-	22.00 .8661	1.50 .0591	6.00 .2362	-	22.00 .8661	1.50 .0591	0.30 .012	7.40 .291	16.60 .654	2522	1.057	X	X	40000	22000
635/22	5.00 .1969	22.00 .8661	6.00 .2362	6.80 .2677	-	-	6.00 .2362	6.80 .2677	-	-	0.60 .024	7.40 .291	19.60 .772	2458	1.053	X	X	43000	25000
676	6.00 .2362	10.00 .3937	2.50 .0984	-	11.20 .4409	0.60 .0236	-	-	-	-	0.15 .006	6.80 .268	9.20 .362	500	216	-	-	35000	-
676/003	6.00 .2362	10.00 .3937	3.00 .1181	-	-	-	3.00 .1181	-	-	-	0.10 .004	6.60 .26	9.40 .370	503	215	X	-	46000	-
676/003	6.00 .2362	10.00 .3937	-	-	-	-	3.00 .1181	-	11.20 .4409	0.60 .0236	0.15 .006	6.80 .268	9.20 .362	500	216	X	-	35000	-
695/1232	6.00 .2362	12.00 .4724	3.00 .1181	-	13.20 .5197	0.60 .0236	-	-	-	-	0.20 .008	7.40 .291	10.60 .417	716	295	-	-	50000	-
695/1202	6.00 .2362	12.00 .4724	4.00 .1575	-	13.60 .5354	0.80 .0315	4.00 .1575	-	13.60 .5354	0.80 .0315	0.15 .006	6.80 .268	11.20 .441	851	366	X	X	49000	28000
686	6.00 .2362	13.00 .5118	3.50 .1307	4.30 .1693	15.00 .5906	1.00 .0394	5.00 .1969	5.80 .2283	15.00 .5906	1.10 .0433	0.15 .006	6.80 .268	12.20 .48	1096	437	X	X	55000	33000
696	6.00 .2362	15.00 .5906	5.00 .1969	-	17.00 .6693	1.20 .0472	5.00 .1969	-	17.00 .6693	1.20 .0472	0.20 .008	7.40 .291	13.60 .535	1340	523	X	X	46000	45000
625/0002	6.00 .2362	16.00 .6299	5.00 .1969	-	18.00 .7087	1.00 .0394	5.00 .1969	-	18.00 .7087	1.00 .0394	0.15 .006	8.40 .331	13.60 .535	1646	663	X	-	41000	-
606	6.00 .2362	17.00 .6693	6.00 .2362	-	19.00 .7480	1.20 .0472	6.00 .2362	-	19.00 .7480	1.20 .0472	0.30 .012	8.00 .315	15.00 .591	2263	846	X	X	45000	30000
626	6.00 .2362	19.00 .7480	6.00 .2362	-	22.00 .8661	1.50 .0591	6.00 .2362	-	22.00 .8661	1.50 .0591	0.30 .012	8.40 .331	16.60 .654	2522	1057	X	X	40000	22000
626/005	6.00 .2362	19.00 .7480	8.00 .3150	-	-	-	8.00 .3150	-	-	-	0.30 .012	8.40 .331	16.60 .654	2522	1057	X	-	48000	-
636	6.00 .2362	22.00 .8661	7.00 .2756	-	-	-	7.00 .2756	-	-	-	0.30 .012	8.40 .331	19.60 .772	3333	1423	X	-	36000	-

Note:

<sup>(1)</sup> r<sub>s min</sub> = minimum single bearing chamfer or maximum permissible shaft or housing fillet radius

<sup>(2)</sup> Other load ratings are possible with different ball complements and non standard retainers

<sup>(3)</sup> Different shields and seals are available

<sup>(4)</sup> Bearings also available with 1 or 2 shields/seals

<sup>(5)</sup> Limiting speed also depends on seal, material and the respective ball complement

• Bearings without shields or retainers are also available with recesses.

• Please discuss your desired design in terms of flange, extended inner ring width, shield, lubrication, and material with our Technical Application Consultants to check availability.

• Subject to change.

• Almost all bearing types can also be enhanced with GRW XTRA. Detailed information you can find on page 79 and following.

# Deep groove radial ball bearings – metric

GRW-designation	Main dimensions in [mm] [inch]		Bearing without closure in [mm] [inch]				Bearing with closure in [mm] [inch]				Chamfer in [mm] [inch]	Mounting dimensions acc. to DIN 5418 [mm] [inch]		Load ratings acc. to DIN ISO <sup>(2)</sup> (max)		Closure options <sup>(3)</sup>		Max. limiting speed <sup>(5)</sup> [mm <sup>-1</sup> ]	
	d	D	Width without closure	Width with extended inner ring without closure	Flange dimensions without closure		Width with closure	Width with extended inner ring with closure	Flange dimensions with closure			r <sub>s min</sub> <sup>(1)</sup>	Shaft diameter	Housing diameter	C <sub>r</sub> [N]	C <sub>0r</sub> [N]	Shield <sup>(4)</sup>	Seal <sup>(4)</sup>	without closure or with shield
Basic symbol			B	B <sub>1</sub>	Flange diameter FD	Flange width FB	B <sub>2</sub>	B <sub>3</sub>	Flange diameter FD <sub>1</sub>	Flange width FB <sub>1</sub>		d <sub>a min</sub>	D <sub>a max</sub>						
677	7.00 .2756	11.00 .4331	2.50 .0984	-	12.20 .4803	0.60 .0236	-	-	-	-	0.10 .004	7.60 .299	10.40 .409	461	206	-	-	50000	-
677/003	7.00 .2756	11.00 .4331	3.00 .1181	-	-	-	3.00 .1181	-	12.20 .4803	0.60 .0236	0.10 .004	7.60 .299	10.40 .409	461	206	X	-	50000	-
688A/1322	7.00 .2756	13.00 .5118	3.00 .1181	-	14.20 .5591	0.60 .0236	4.00 .1575	-	14.60 .5748	0.80 .0315	0.15 .006	8.40 .331	11.60 .457	541	276	X	X	48000	30000
688/1322	7.00 .2756	13.00 .5118	-	-	-	-	4.00 .1575	-	-	-	0.20 .008	8.40 .331	11.60 .457	335	152	X	-	35000	-
687	7.00 .2756	14.00 .5512	3.50 .1307	-	16.00 .6299	1.00 .0394	5.00 .1969	-	16.00 .6299	1.10 .0433	0.15 .006	7.80 .307	13.20 .520	1186	505	X	X	50000	31000
697	7.00 .2756	17.00 .6693	5.00 .1969	-	19.00 .7480	1.20 .0472	5.00 .1969	-	19.00 .7480	1.20 .0472	0.30 .012	9.00 .354	15.00 .591	1795	776	X	X	39000	28000
607	7.00 .2756	19.00 .7480	6.00 .2362	-	22.00 .8661	1.50 .0591	6.00 .2362	-	22.00 .8661	1.50 .0591	0.30 .012	9.00 .350	17.00 .669	3400	1057	X	X	43000	22000
627	7.00 .2756	22.00 .8661	7.00 .2756	-	25.00 .9843	1.50 .0591	7.00 .2756	-	25.00 .9843	1.50 .0591	0.30 .012	9.40 .370	19.60 .772	3369	1363	X	X	35000	21000
627/28	7.00 .2756	28.00 1.1024	7.00 .2756	7.80 .3071	-	-	7.00 .2756	7.80 .3071	-	-	0.30 .012	9.40 .370	25.80 1.016	3369	1363	X	-	40000	-
678	8.00 .3150	12.00 .4724	2.50 .0984	-	13.20 .5197	0.60 .0236	-	-	-	-	0.10 .004	8.60 .339	11.40 .449	540	275	-	-	48000	-
678/003	8.00 .3150	12.00 .4724	-	-	-	-	3.50 .1307	-	13.60 .5354	0.80 .0315	0.10 .004	8.60 .339	11.40 .449	540	275	X	-	48000	-
688A/144	8.00 .3150	14.00 .5512	3.50 .1307	-	15.60 .6142	0.80 .0315	-	-	-	-	0.15 .006	8.80 .346	13.20 .520	817	386	-	-	45000	-
688A/142	8.00 .3150	14.00 .5512	-	-	-	-	4.00 .1575	-	15.60 .6142	0.80 .0315	0.20 .008	9.40 .370	12.60 .496	817	386	X	-	47000	-
688	8.00 .3150	16.00 .6299	4.00 .1575	-	18.00 .7087	1.00 .0394	6.00 .2362	-	18.00 .7087	1.30 .0512	0.20 .008	9.40 .370	14.60 .575	1795	776	X	X	48000	28000
688/002	8.00 .3150	16.00 .6299	-	-	-	-	4.00 .1575	-	-	-	0.20 .008	9.40 .370	14.60 .575	1795	776	X	-	48000	-
688/003	8.00 .3150	16.00 .6299	5.00 .1969	-	18.00 .7087	1.10 .0433	5.00 .1969	-	18.00 .7087	1.10 .0433	0.20 .008	9.40 .370	14.60 .575	1795	776	X	X	43000	28000
698	8.00 .3150	19.00 .7480	6.00 .2362	-	22.00 .8661	1.50 .0591	6.00 .2362	-	22.00 .8661	1.50 .0591	0.30 .012	10.00 .394	17.00 .669	2240	917	X	X	43000	27000
688/20	8.00 .3150	20.00 .7874	4.00 .1575	4.80 .1890	-	-	-	-	-	-	0.20 .008	9.40 .370	18.60 .732	1795	776	-	-	45000	-

Note:

<sup>(1)</sup> r<sub>s min</sub> = minimum single bearing chamfer or maximum permissible shaft or housing fillet radius

<sup>(2)</sup> Other load ratings are possible with different ball complements and non standard retainers

<sup>(3)</sup> Different shields and seals are available

<sup>(4)</sup> Bearings also available with 1 or 2 shields/seals

<sup>(5)</sup> Limiting speed also depends on seal, material and the respective ball complement

• Bearings without shields or retainers are also available with recesses.

• Please discuss your desired design in terms of flange, extended inner ring width, shield, lubrication, and material with our Technical Application Consultants to check availability.

• Subject to change.

• Almost all bearing types can also be enhanced with GRW XTRA. Detailed information you can find on page 79 and following.

# Deep groove radial ball bearings – metric

GRW-designation	Main dimensions in [mm] [inch]		Bearing without closure in [mm] [inch]				Bearing with closure in [mm] [inch]				Chamfer in [mm] [inch]	Mounting dimensions acc. to DIN 5418 [mm] [inch]		Load ratings acc. to DIN ISO <sup>(2)</sup> (max)		Closure options <sup>(3)</sup>		Max. limiting speed <sup>(5)</sup> [mm <sup>-1</sup> ]	
	d	D	Width without closure	Width with extended inner ring without closure	Flange dimensions without closure		Width with closure	Width with extended inner ring with closure	Flange dimensions with closure			r <sub>s min</sub> <sup>(1)</sup>	Shaft diameter	Housing diameter	C <sub>r</sub> [N]	C <sub>0r</sub> [N]	Shield <sup>(4)</sup>	Seal <sup>(4)</sup>	without closure or with shield
Basic symbol	d	D	B	B <sub>1</sub>	Flange diameter FD	Flange width FB	B <sub>2</sub>	B <sub>3</sub>	Flange diameter FD <sub>1</sub>	Flange width FB <sub>1</sub>		d <sub>a min</sub>	D <sub>a max</sub>						
608/003	8.00 .3150	22.00 .8661	6.00 .2362	-	-	-	-	-	-	-	0.30 .012	10.00 .394	20.00 .787	3369	1363	-	-	38000	-
608	8.00 .3150	22.00 .8661	7.00 .2756	-	25.00 .9843	1.50 .0591	7.00 .2756	-	25.00 .9843	1.50 .0591	0.30 .012	10.00 .394	20.00 .787	3369	1363	X	X	38000	21000
608/005	8.00 .3150	22.00 .8661	10.00 .3937	-	-	-	10.00 .3937	-	-	-	0.30 .012	10.00 .394	20.00 .787	3369	1363	X	-	43000	-
608/006	8.00 .3150	22.00 .8661	10.31 .4059	-	-	-	10.31 .4059	-	-	-	0.30 .012	10.00 .394	20.00 .787	3369	1363	X	X	43000	29000
608/007	8.00 .3150	22.00 .8661	11.00 .4331	-	-	-	11.00 .4331	-	-	-	0.30 .012	10.00 .394	20.00 .787	3369	1363	X	X	43000	29000
628	8.00 .3150	24.00 .9449	8.00 .3150	-	-	-	8.00 .3150	-	-	-	0.30 .012	10.40 .409	21.60 .850	3360	1430	X	X	38000	21000
6000/0001	8.00 .3150	26.00 1.0236	8.00 .3150	-	-	-	8.00 .3150	-	-	-	0.30 .012	10.40 .409	24.00 .945	4698	1982	X	-	35000	-
638	8.00 .3150	28.00 1.1024	9.00 .3543	-	-	-	9.00 .3543	-	-	-	0.30 .012	10.40 .409	25.60 1.008	4563	1982	X	-	34000	-
679	9.00 .3543	14.00 .5512	3.00 .1181	-	15.50 .6102	0.80 .0315	-	-	-	-	0.10 .004	9.60 .378	13.40 .528	919	468	-	-	42000	-
679/003	9.00 .3543	14.00 .5512	4.50 .1772	-	15.50 .6102	0.80 .0315	4.50 .1772	-	15.50 .6102	0.80 .0315	0.10 .004	9.60 .378	13.40 .528	919	468	X	X	42000	25000
689	9.00 .3543	17.00 .6693	4.00 .1575	4.80 .1890	19.00 .7480	1.00 .0394	6.00 .2362	-	19.00 .7480	1.30 .0512	0.20 .008	10.40 .409	15.60 .614	1798	797	X	X	44000	27000
689/003	9.00 .3543	17.00 .6693	5.00 .1969	-	-	-	5.00 .1969	-	-	-	0.20 .008	10.40 .409	15.60 .614	1798	797	X	-	44000	-
699	9.00 .3543	20.00 .7874	6.00 .2362	6.80 .2677	23.00 .9055	1.50 .0591	6.00 .2362	6.80 .2677	23.00 .9055	1.50 .0591	0.30 .012	11.00 .433	18.00 .709	2467	1081	X	X	40000	25000
609	9.00 .3543	24.00 .9449	7.00 .2756	-	27.00 1.0630	1.50 .0591	7.00 .2756	-	27.00 1.0630	1.50 .0591	0.30 .012	11.00 .433	22.00 .866	3435	1430	X	X	33000	20000
629	9.00 .3543	26.00 1.0236	8.00 .3150	8.80 .3465	28.00 1.1024	2.00 .0787	8.00 .3150	8.80 .3465	28.00 1.1024	2.00 .0787	0.30 .012	11.40 .449	23.60 .929	4.698	1982	X	X	34000	19000
6700	10.00 .3937	15.00 .5906	3.00 .1181	-	16.50 .6496	0.80 .0315	-	-	16.50 .6496	0.80 .0315	0.15 .006	10.80 .425	14.20 .559	855	435	-	-	17000	-
6700/003	10.00 .3937	15.00 .5906	4.00 .1575	-	16.50 .6496	0.80 .0315	4.00 .1575	-	16.50 .6496	0.80 .0315	0.15 .006	10.80 .425	14.20 .559	855	435	X	X	17000	10000
6800 (4)	10.00 .3937	19.00 .7480	5.00 .1969	5.80 .2283	21.00 .8268	1.00 .0394	7.00 .2756	7.80 .3071	21.00 .8268	1.50 .0591	0.30 .012	12.00 .472	17.00 .669	1922	915	X	X	42000	25000

Note:

<sup>(1)</sup> r<sub>s min</sub> = minimum single bearing chamfer or maximum permissible shaft or housing fillet radius

<sup>(2)</sup> Other load ratings are possible with different ball complements and non standard retainers

<sup>(3)</sup> Different shields and seals are available

<sup>(4)</sup> Bearings also available with 1 or 2 shields/seals

<sup>(5)</sup> Limiting speed also depends on seal, material and the respective ball complement

• Bearings without shields or retainers are also available with recesses.

• Please discuss your desired design in terms of flange, extended inner ring width, shield, lubrication, and material with our Technical Application Consultants to check availability.

• Subject to change.

• Almost all bearing types can also be enhanced with GRW XTRA. Detailed information you can find on page 79 and following.



# Deep groove radial ball bearings – metric

GRW-designation	Main dimensions in [mm] [inch]		Bearing without closure in [mm] [inch]				Bearing with closure in [mm] [inch]				Chamfer in [mm] [inch]	Mounting dimensions acc. to DIN 5418 [mm] [inch]		Load ratings acc. to DIN ISO <sup>(2)</sup> (max)		Closure options <sup>(3)</sup>		Max. limiting speed <sup>(5)</sup> [mm <sup>-1</sup> ]	
	d	D	Width without closure	Width with extended inner ring without closure	Flange dimensions without closure		Width with closure	Width with extended inner ring with closure	Flange dimensions with closure			r <sub>s min</sub> <sup>(1)</sup>	Shaft diameter	Housing diameter	C <sub>r</sub> [N]	C <sub>0r</sub> [N]	Shield <sup>(4)</sup>	Seal <sup>(4)</sup>	without closure or with shield
Basic symbol			B	B <sub>1</sub>	Flange diameter FD	Flange width FB	B <sub>2</sub>	B <sub>3</sub>	Flange diameter FD <sub>1</sub>	Flange width FB <sub>1</sub>		d <sub>a min</sub>	D <sub>a max</sub>						
6800/002	10.00 .3937	19.00 .7480	-	-	-	-	5.00 .1969	-	21.00 .8268	1.00 .0394	0.30 .012	12.00 .472	17.00 .669	1922	915	X	-	34000	-
6800/003	10.00 .3937	19.00 .7480	6.00 .2362	-	-	-	6.00 .2362	-	-	-	0.30 .012	12.00 .472	17.00 .669	1922	915	X	-	35000	-
6800/202	10.00 .3937	20.00 .7874	-	-	-	-	5.00 .1969	-	-	-	0.30 .012	12.00 .472	18.00 .709	1922	915	X	-	34000	-
6900	10.00 .3937	22.00 .8661	6.00 .2362	-	25.00 .9843	1.50 .0591	6.00 .2362	-	25.00 .9843	1.50 .0591	0.30 .012	12.00 .472	20.00 .787	2695	1273	X	X	41000	24000
6000	10.00 .3937	26.00 1.0236	8.00 .3150	8.80 .3465	28.00 1.1024	2.00 .0787	8.00 .3150	8.80 .3465	28.00 1.1024	2.00 .0787	0.30 .012	12.40 .488	23.60 .929	4698	1982	X	X	35000	19000
6000/003	10.00 .3937	26.00 1.0236	10.00 .3937	-	-	-	10.00 .3937	-	-	-	0.30 .012	12.40 .488	23.60 .929	4149	1388	X	-	38000	-
16100	10.00 .3937	28.00 1.1024	8.00 .3150	-	-	-	8.00 .3150	-	-	-	0.30 .012	14.20 .559	23.80 .937	4620	1960	X	-	37000	-
6200	10.00 .3937	30.00 1.1811	9.00 .3543	-	-	-	9.00 .3543	-	-	-	0.60 .024	14.20 .559	25.80 1.016	4340	1920	X	X	27000	18000
6300	10.00 .3937	35.00 1.3780	11.00 .4331	-	-	-	11.00 .4331	-	-	-	0.60 .024	14.20 .559	20.80 .819	6870	2750	X	X	27000	18000
6701	12.00 .4724	18.00 .7087	4.00 .1575	-	19.50 .7677	0.80 .0315	4.00 .1575	-	19.50 .7677	0.80 .0315	0.20 .008	13.40 .528	16.60 .654	926	530	X	X	15000	10000
6801	12.00 .4724	21.00 .8268	5.00 .1969	-	-	-	5.00 .1969	-	-	-	0.30 .012	14.00 .551	19.00 .748	1930	900	X	-	30000	-
6801/003	12.00 .4724	21.00 .8268	6.00 .2362	-	-	-	6.00 .2362	-	-	-	0.30 .012	14.00 .551	19.00 .748	1720	840	X	-	32000	-
6801/004	12.00 .4724	21.00 .8268	7.00 .2756	-	23.00 .9055	1.50 .0591	7.00 .2756	-	23.00 .9055	1.50 .0591	0.30 .012	14.00 .551	19.00 .748	1915	1041	X	X	39000	24000
6901	12.00 .4724	24.00 .9449	6.00 .2362	-	-	-	6.00 .2362	-	-	-	0.30 .012	14.00 .551	22.00 .866	2971	1460	X	-	32000	-
16001	12.00 .4724	28.00 1.1024	7.00 .2756	-	-	-	7.00 .2756	-	-	-	0.30 .012	14.00 .551	26.00 1.024	5100	2370	-	-	32000	-
6001	12.00 .4724	28.00 1.1024	8.00 .3150	-	30.00 1.1811	2.00 .0787	8.00 .3150	-	30.00 1.1811	2.00 .0787	0.30 .012	14.00 .551	26.00 1.024	5237	2370	X	X	31000	17000
6001/003	12.00 .4724	28.00 1.1024	11.00 .4331	-	-	-	11.00 .4331	-	-	-	0.30 .012	14.00 .551	26.00 1.024	5237	2359	X	-	31000	-
63001	12.00 .4724	28.00 1.1024	12.00 .4724	-	-	-	12.00 .4724	-	-	-	0.50 .020	14.00 .551	26.00 1.024	5100	2370	X	X	30000	16000

Note:

<sup>(1)</sup> r<sub>s min</sub> = minimum single bearing chamfer or maximum permissible shaft or housing fillet radius

<sup>(2)</sup> Other load ratings are possible with different ball complements and non standard retainers

<sup>(3)</sup> Different shields and seals are available

<sup>(4)</sup> Bearings also available with 1 or 2 shields/seals

<sup>(5)</sup> Limiting speed also depends on seal, material and the respective ball complement

• Bearings without shields or retainers are also available with recesses.

• Please discuss your desired design in terms of flange, extended inner ring width, shield, lubrication, and material with our Technical Application Consultants to check availability.

• Subject to change.

• Almost all bearing types can also be enhanced with GRW XTRA. Detailed information you can find on page 79 and following.

# Deep groove radial ball bearings – metric

GRW-designation	Main dimensions in [mm] [inch]		Bearing without closure in [mm] [inch]				Bearing with closure in [mm] [inch]				Chamfer in [mm] [inch]	Mounting dimensions acc. to DIN 5418 [mm] [inch]		Load ratings acc. to DIN ISO <sup>(2)</sup> (max)		Closure options <sup>(3)</sup>		Max. limiting speed <sup>(5)</sup> [mm <sup>-1</sup> ]	
	d	D	Width without closure	Width with extended inner ring without closure	Flange dimensions without closure		Width with closure	Width with extended inner ring with closure	Flange dimensions with closure			r <sub>s min</sub> <sup>(1)</sup>	Shaft diameter	Housing diameter	C <sub>r</sub> [N]	C <sub>0r</sub> [N]	Shield <sup>(4)</sup>	Seal <sup>(4)</sup>	without closure or with shield
Basic symbol			B	B <sub>1</sub>	Flange diameter FD	Flange width FB	B <sub>2</sub>	B <sub>3</sub>	Flange diameter FD <sub>1</sub>	Flange width FB <sub>1</sub>		d <sub>a min</sub>	D <sub>a max</sub>						
16101	<b>12.00</b> .4724	<b>30.00</b> 1.1811	<b>8.00</b> .3150	-	-	-	<b>8.00</b> .3150	-	-	-	<b>0.50</b> .020	<b>14.40</b> .567	<b>27.60</b> 1.087	5070	2360	X	X	28000	16000
6201	<b>12.00</b> .4724	<b>32.00</b> 1.2598	<b>10.00</b> .3937	-	-	-	<b>10.00</b> .3937	-	-	-	<b>0.60</b> .024	<b>16.20</b> .638	<b>27.80</b> 1.094	5770	2450	X	X	26000	15000
62201	<b>12.00</b> .4724	<b>32.00</b> 1.2598	<b>14.00</b> .5512	-	-	-	<b>14.00</b> .5512	-	-	-	<b>0.60</b> .024	<b>16.20</b> .638	<b>27.80</b> 1.094	6890	3100	X	X	25000	15000
6301	<b>12.00</b> .4724	<b>37.00</b> 1.4567	<b>12.00</b> .4724	-	-	-	<b>12.00</b> .4724	-	-	-	<b>1.00</b> .039	<b>17.60</b> .693	<b>31.40</b> 1.236	8240	3360	X	X	25000	14000
62301	<b>12.00</b> .4724	<b>37.00</b> 1.4567	<b>17.00</b> .6693	-	-	-	<b>17.00</b> .6693	-	-	-	<b>1.00</b> .039	<b>17.60</b> .693	<b>31.40</b> 1.236	8240	3360	-	X	27000	14000
6702	<b>15.00</b> .5906	<b>21.00</b> .8268	<b>4.00</b> .1575	-	-	-	<b>4.00</b> .1575	-	-	-	<b>0.20</b> .008	<b>16.40</b> .646	<b>19.60</b> .772	937	582	X	X	13000	9000
6802	<b>15.00</b> .5906	<b>24.00</b> .9449	<b>5.00</b> .1969	-	-	-	<b>5.00</b> .1969	-	-	-	<b>0.30</b> .012	<b>17.00</b> .669	<b>22.00</b> .866	2080	1100	X	X	25000	15000
6802/003	<b>15.00</b> .5906	<b>24.00</b> .9449	<b>7.00</b> .2756	-	<b>26.00</b> 1.0236	<b>1.50</b> .0591	<b>7.00</b> .2756	-	<b>26.00</b> 1.0236	<b>1.50</b> .0591	<b>0.30</b> .012	<b>17.00</b> .669	<b>22.00</b> .866	2073	1253	X	X	33000	18000
6902	<b>15.00</b> .5906	<b>28.00</b> 1.1024	<b>7.00</b> .2756	-	-	-	<b>7.00</b> .2756	-	-	-	<b>0.30</b> .012	<b>17.00</b> .669	<b>26.00</b> 1.024	4445	2268	X	X	24000	16000
16002	<b>15.00</b> .5906	<b>32.00</b> 1.2598	<b>8.</b> .3150	-	-	-	<b>8.00</b> .3150	-	-	-	<b>0.50</b> .020	<b>17.00</b> .669	<b>30.00</b> 1.181	5600	2830	X	X	26000	14000
6002	<b>15.00</b> .5906	<b>32.00</b> 1.2598	<b>9.00</b> .3543	-	-	-	<b>9.00</b> .3543	-	-	-	<b>0.30</b> .012	<b>17.00</b> .669	<b>30.00</b> 1.181	5676	2819	X	-	25000	-
6202	<b>15.00</b> .5906	<b>35.00</b> 1.3780	<b>11.00</b> .4331	-	-	-	<b>11.00</b> .4331	-	-	-	<b>0.60</b> .024	<b>19.20</b> .756	<b>30.80</b> 1.213	6490	3000	X	X	24000	16000
62202	<b>15.00</b> .5906	<b>35.00</b> 1.3780	<b>14.00</b> .5512	-	-	-	<b>14.00</b> .5512	-	-	-	<b>0.60</b> .024	<b>19.20</b> .756	<b>30.80</b> 1.213	7650	3750	X	X	23000	13000
6302	<b>15.00</b> .5906	<b>42.00</b> 1.6535	<b>13.00</b> .5118	-	-	-	<b>13.00</b> .5118	-	-	-	<b>1.50</b> .059	<b>24.00</b> .945	<b>33.00</b> 1.299	11400	5450	X	X	21000	11000
6703	<b>17.00</b> .6693	<b>23.00</b> .9055	<b>4.00</b> .1575	-	<b>24.50</b> .9646	<b>0.80</b> .0315	<b>4.00</b> .1575	-	<b>24.50</b> .9646	<b>0.80</b> .0315	<b>0.20</b> .008	<b>18.40</b> .724	<b>21.60</b> .850	1000	658	X	X	11000	7000
6803	<b>17.00</b> .6693	<b>26.00</b> 1.0236	<b>5.00</b> .1969	-	-	-	<b>5.00</b> .1969	-	-	-	<b>0.30</b> .012	<b>19.00</b> .748	<b>24.00</b> .945	2240	1270	X	-	22000	-
6903	<b>17.00</b> .6693	<b>30.00</b> 1.1811	<b>7.00</b> .2756	-	-	-	<b>7.00</b> .2756	-	-	-	<b>0.30</b> .012	<b>1.00</b> .748	<b>28.00</b> 1.102	4723	2547	X	-	21000	-
16003	<b>17.00</b> .6693	<b>35.00</b> 1.378	<b>8.00</b> .3150	-	-	-	<b>8.00</b> .3150	-	-	-	<b>0.30</b> .012	<b>19.00</b> .748	<b>33.00</b> 1.299	6000	3250	X	-	23500	-

Note:

<sup>(1)</sup> r<sub>s min</sub> = minimum single bearing chamfer or maximum permissible shaft or housing fillet radius

<sup>(2)</sup> Other load ratings are possible with different ball complements and non standard retainers

<sup>(3)</sup> Different shields and seals are available

<sup>(4)</sup> Bearings also available with 1 or 2 shields/seals

<sup>(5)</sup> Limiting speed also depends on seal, material and the respective ball complement

• Bearings without shields or retainers are also available with recesses.

• Please discuss your desired design in terms of flange, extended inner ring width, shield, lubrication, and material with our Technical Application Consultants to check availability.

• Subject to change.

• Almost all bearing types can also be enhanced with GRW XTRA. Detailed information you can find on page 79 and following.

# Deep groove radial ball bearings – metric

GRW-designation	Main dimensions in [mm] [inch]		Bearing without closure in [mm] [inch]				Bearing with closure in [mm] [inch]				Chamfer in [mm] [inch]	Mounting dimensions acc. to DIN 5418 [mm] [inch]		Load ratings acc. to DIN ISO <sup>(2)</sup> (max)		Closure options <sup>(3)</sup>		Max. limiting speed <sup>(5)</sup> [mm <sup>-1</sup> ]	
	d	D	Width without closure	Width with extended inner ring without closure	Flange dimensions without closure		Width with closure	Width with extended inner ring with closure	Flange dimensions with closure			r <sub>s min</sub> <sup>(1)</sup>	Shaft diameter	Housing diameter	C <sub>r</sub> [N]	C <sub>0r</sub> [N]	Shield <sup>(4)</sup>	Seal <sup>(4)</sup>	without closure or with shield
Basic symbol			B	B <sub>1</sub>	Flange diameter FD	Flange width FB	B <sub>2</sub>	B <sub>3</sub>	Flange diameter FD <sub>1</sub>	Flange width FB <sub>1</sub>		d <sub>a min</sub>	D <sub>a max</sub>						
6003	<b>17.00</b> .6693	<b>35.00</b> 1.3780	<b>10.00</b> .3937	-	-	-	<b>10.00</b> .3937	-	-	-	<b>0.30</b> .012	<b>19.00</b> .748	<b>33.00</b> 1.299	5090	2630	X	X	23000	18000
6203	<b>17.00</b> .6693	<b>40.00</b> 1.5748	<b>12.00</b> .4724	-	-	-	<b>12.00</b> .4724	-	-	-	<b>0.60</b> .024	<b>21.20</b> .835	<b>35.80</b> 1.409	8130	3850	X	X	20000	15000
62203	<b>17.00</b> .6693	<b>40.00</b> 1.5748	<b>16.00</b> .6299	-	-	-	<b>16.00</b> .6299	-	-	-	<b>0.60</b> .024	<b>21.20</b> .835	<b>35.80</b> 1.409	9560	4750	X	-	21000	-
6303	<b>17.00</b> .6693	<b>47.00</b> 1.8504	<b>14.00</b> .5512	-	-	-	<b>14.00</b> .5512	-	-	-	<b>1.00</b> .039	<b>22.60</b> .890	<b>41.40</b> 1.630	11550	5330	X	X	18000	14000
6704	<b>20.00</b> .7874	<b>27.00</b> 1.0630	<b>4.00</b> .1575	-	<b>28.50</b> 1.122	<b>0.80</b> .0315	<b>4.00</b> .1575	-	<b>28.50</b> 1.122	<b>0.80</b> .0315	<b>0.20</b> .008	<b>22.00</b> .866	<b>25.60</b> 1.008	1402	729	X	X	10000	7000
6804	<b>20.00</b> .7874	<b>32.00</b> 1.2598	<b>7.00</b> .2756	-	<b>35.00</b> 1.378	<b>1.50</b> .0591	<b>7.00</b> .2756	-	<b>35.00</b> 1.378	<b>1.50</b> .0591	<b>0.30</b> .012	<b>22.00</b> .866	<b>30.00</b> 1.181	4015	2462	X	X	25000	13000
6904	<b>20.00</b> .7874	<b>37.00</b> 1.4567	<b>9.00</b> .3543	-	<b>40.00</b> 1.5748	<b>2.00</b> .0787	<b>9.00</b> .3543	<b>2.00</b> .0787	<b>40.00</b> 1.5748	<b>2.00</b> .0787	<b>0.30</b> .012	<b>22.00</b> .866	<b>35.00</b> 1.378	6381	3682	X	X	23000	12000
16004	<b>20.00</b> .7874	<b>42.00</b> 1.6535	<b>8.00</b> .3150				<b>8.00</b> .3150				<b>0.30</b> .012	<b>22.00</b> .866	<b>40.00</b> 1.575	6940	4100	X	-	21000	-
6004	<b>20.00</b> .7874	<b>42.00</b> 1.6535	<b>12.00</b> .4724	-	-	-	<b>12.00</b> .4724	-	-	-	<b>1.00</b> .039	<b>24.60</b> .969	<b>37.40</b> 1.472	7900	4250	X	X	21000	11000
6204	<b>20.00</b> .7874	<b>47.00</b> 1.8504	<b>14.00</b> .5512	-	-	-	<b>14.00</b> .5512	-	-	-	<b>1.00</b> .039	<b>25.60</b> 1.008	<b>41.40</b> 1.630	10910	5360	X	X	17000	10000
6705	<b>25.00</b> .9843	<b>32.00</b> 1.2598	<b>4.00</b> .1575	-	-	-	<b>4.00</b> .1575	-	<b>34.00</b> 1.3386	<b>1.00</b> .0394	<b>0.20</b> .008	<b>27.00</b> 1.063	<b>30.60</b> 1.205	1091	838	-	X	12000	8000
6805	<b>25.00</b> .9843	<b>37.00</b> 1.4567	<b>7.00</b> .2756	-	<b>40.00</b> 1.5748	<b>1.50</b> .0591	<b>7.00</b> .2756	-	<b>40.00</b> 1.5748	<b>1.50</b> .0591	<b>0.30</b> .012	<b>27.00</b> 1.063	<b>35.00</b> 1.378	4303	2932	X	-	21000	-
6905	<b>25.00</b> .9843	<b>42.00</b> 1.6535	<b>9.00</b> .3543	-	<b>45.00</b> 1.7717	<b>2.00</b> .0787	<b>9.00</b> .3543	-	<b>45.00</b> 1.7717	<b>2.00</b> .0787	<b>0.30</b> .012	<b>27.00</b> 1.063	<b>40.00</b> 1.575	7001	4540	X	X	19000	10000
16005	<b>25.00</b> .9843	<b>47.00</b> 1.8504	<b>8.00</b> .3150	-	-	-	<b>8.00</b> .3150	-	-	-	<b>0.60</b> .024	<b>27.00</b> 1.063	<b>45.00</b> 1.772	8550	4690	X	-	17000	-
6005	<b>25.00</b> .9843	<b>47.00</b> 1.8504	<b>12.00</b> .4724	-	-	-	<b>12.00</b> .4724	-	-	-	<b>0.60</b> .024	<b>28.20</b> 1.110	<b>43.80</b> 1.724	8550	4690	X	X	18000	9500
6706	<b>30.00</b> 1.1811	<b>37.00</b> 1.4567	<b>4.00</b> .1575	-	<b>39.00</b> 1.5354	<b>1.00</b> .0394	<b>4.00</b> .1575	-	<b>39.00</b> 1.5354	<b>1.00</b> .0394	<b>0.20</b> .008	<b>32.00</b> 1.260	<b>35.60</b> 1.402	1143	947	X	-	17000	-
6806	<b>30.00</b> 1.1811	<b>42.00</b> 1.6535	<b>7.00</b> .2756	-	<b>45.00</b> 1.7717	<b>1.50</b> .0591	<b>7.00</b> .2756	-	<b>45.00</b> 1.7717	<b>1.50</b> .0591	<b>0.30</b> .012	<b>32.00</b> 1.260	<b>40.00</b> 1.575	4538	3402	X	X	18000	9000
6906	<b>30.00</b> 1.1811	<b>47.00</b> 1.8504	<b>9.00</b> .3543	-	<b>50.00</b> 1.9685	<b>2.00</b> .0787	<b>9.00</b> .3543	-	<b>50.00</b> 1.9685	<b>2.00</b> .0787	<b>0.30</b> .012	<b>32.00</b> 1.260	<b>45.00</b> 1.772	7242	5003	X	X	17000	8500

Note:

<sup>(1)</sup> r<sub>s min</sub> = minimum single bearing chamfer or maximum permissible shaft or housing fillet radius

<sup>(2)</sup> Other load ratings are possible with different ball complements and non standard retainers

<sup>(3)</sup> Different shields and seals are available

<sup>(4)</sup> Bearings also available with 1 or 2 shields/seals

<sup>(5)</sup> Limiting speed also depends on seal, material and the respective ball complement

• Bearings without shields or retainers are also available with recesses.

• Please discuss your desired design in terms of flange, extended inner ring width, shield, lubrication, and material with our Technical Application Consultants to check availability.

• Subject to change.

• Almost all bearing types can also be enhanced with GRW XTRA. Detailed information you can find on page 79 and following.

# Deep groove radial ball bearings – metric

GRW-designation	Main dimensions in [mm] [inch]		Bearing without closure in [mm] [inch]				Bearing with closure in [mm] [inch]				Chamfer in [mm] [inch]	Mounting dimensions acc. to DIN 5418 [mm] [inch]		Load ratings acc. to DIN ISO <sup>(2)</sup> (max)		Closure options <sup>(3)</sup>		Max. limiting speed <sup>(5)</sup> [mm <sup>-1</sup> ]	
	d	D	Width without closure	Width with extended inner ring without closure	Flange dimensions without closure		Width with closure	Width with extended inner ring with closure	Flange dimensions with closure			$r_{s\ min}^{(1)}$	Shaft diameter $d_{a\ min}$	Housing diameter $D_{a\ max}$	$C_r$ [N]	$C_{Or}$ [N]	Shield <sup>(4)</sup>	Seal <sup>(4)</sup>	without closure or with shield
6807	<b>35.00</b> 1.3780	<b>47.00</b> 1.8504	<b>7.00</b> .2756	-	<b>50.00</b> 1.9685	<b>1.50</b> .0591	<b>7.00</b> .2756	-	<b>50.00</b> 1.9685	<b>1.50</b> .0591	<b>0.30</b> .012	<b>37.00</b> 1.457	<b>45.00</b> 1.772	4729	3821	X	X	16000	8000

## Your Notes:

Note:

<sup>(1)</sup>  $r_{s\ min}$  = minimum single bearing chamfer or maximum permissible shaft or housing fillet radius

<sup>(2)</sup> Other load ratings are possible with different ball complements and non standard retainers

<sup>(3)</sup> Different shields and seals are available

<sup>(4)</sup> Bearings also available with 1 or 2 shields/seals

<sup>(5)</sup> Limiting speed also depends on seal, material and the respective ball complement

- Bearings without shields or retainers are also available with recesses.
- Please discuss your desired design in terms of flange, extended inner ring width, shield, lubrication, and material with our Technical Application Consultants to check availability.

- Subject to change.
- Almost all bearing types can also be enhanced with GRW XTRA. Detailed information you can find on page 79 and following.

# Deep groove radial ball bearings – inch

GRW designation	Main dimensions in [mm] [inch]		Bearing without closure in [mm] [inch]				Bearing with closure in [mm] [inch]				Chamfer in [mm] [inch]	Mounting dimensions acc. to ANSI/AFBMA Std. 12.2 in [mm] [inch]		Load ratings acc. to DIN ISO (2) (max)		Closure options (3)		Max. limiting speed (5) [mm <sup>-1</sup> ]		
	d	D	Width without closure	Width with extended inner ring without closure	Flange dimensions without closure		Width with closure	Width with extended inner ring with closure	Flange dimensions with closure			r <sub>s min</sub> (1)	Shaft diameter d <sub>a min</sub>	Housing diameter D <sub>a max</sub>	C [N]	C <sub>0r</sub> [N]	Shield (4)	Seal (4)	without closure or with shield	with seal
Basic symbol			B	B <sub>1</sub>	Flange diameter FD	Flange width FB	B <sub>2</sub>	B <sub>3</sub>	Flange diameter FD <sub>1</sub>	Flange width FB <sub>1</sub>										
1016	1.016 <b>.0400</b>	3.175 <b>.1250</b>	1.191 <b>.0469</b>	–	–	–	–	–	–	–	0.08 <b>.003</b>	1.50 <b>.059</b>	2.65 <b>.104</b>	106	28	–	–	150000	–	
1191	1.191 <b>.0469</b>	3.967 <b>.1562</b>	1.588 <b>.0625</b>	2.381 <b>.0937</b>	5.156 <b>.2030</b>	0.330 <b>.0130</b>	–	–	–	–	0.08 <b>.003</b>	1.80 <b>.071</b>	3.35 <b>.132</b>	163	44	–	–	129000	–	
1397	1.397 <b>.0550</b>	4.763 <b>.1875</b>	1.984 <b>.0781</b>	–	–	–	2.779 <b>.1094</b>	–	5.944 <b>.2340</b>	0.787 <b>.03100</b>	0.08 <b>.003</b>	2.00 <b>.079</b>	4.15 <b>.163</b>	239	67	X	–	114000	–	
5/64	1.984 <b>.0781</b>	6.350 <b>.2500</b>	2.380 <b>.0937</b>	3.175 <b>.1250</b>	7.518 <b>.2960</b>	0.584 <b>.0230</b>	3.571 <b>.1406</b>	4.366 <b>.1719</b>	7.518 <b>.2960</b>	0.787 <b>.0310</b>	0.08 <b>.003</b>	2.60 <b>.102</b>	5.75 <b>.226</b>	286	90	X	–	95000	–	
2380	2.380 <b>.0937</b>	4.763 <b>.1875</b>	1.588 <b>.0625</b>	2.380 <b>.0937</b>	5.944 <b>.2340</b>	0.457 <b>.0180</b>	2.380 <b>.0937</b>	3.175 <b>.1250</b>	5.944 <b>.2340</b>	0.787 <b>.0310</b>	0.08 <b>.003</b>	2.90 <b>.114</b>	4.25 <b>.167</b>	192	59	X	–	94000	–	
3175/0002	2.380 <b>.0937</b>	6.350 <b>.2500</b>	2.779 <b>.1094</b>	–	7.518 <b>.2960</b>	0.787 <b>.0310</b>	2.779 <b>.1094</b>	–	7.518 <b>.2960</b>	0.787 <b>.0310</b>	0.08 <b>.003</b>	2.95 <b>.116</b>	5.75 <b>.226</b>	292	97	X	–	82000	–	
3/32	2.380 <b>.0937</b>	7.938 <b>.3125</b>	2.779 <b>.1094</b>	3.571 <b>.1406</b>	9.119 <b>.3590</b>	0.584 <b>.0230</b>	3.571 <b>.1406</b>	4.366 <b>.1719</b>	9.119 <b>.3590</b>	0.787 <b>.0310</b>	0.08 <b>.003</b>	3.10 <b>.122</b>	7.25 <b>.285</b>	644	215	X	X	62000	51000	
3175/002	3.175 <b>.1250</b>	6.350 <b>.2500</b>	–	–	–	–	2.380 <b>.0937</b>	–	7.518 <b>.2960</b>	0.584 <b>.0230</b>	0.08 <b>.003</b>	3.75 <b>.148</b>	5.75 <b>.226</b>	311	109	X	–	80000	–	
3175	3.175 <b>.1250</b>	6.350 <b>.2500</b>	2.380 <b>.0937</b>	3.175 <b>.1250</b>	7.518 <b>.2960</b>	0.584 <b>.0230</b>	2.779 <b>.1094</b>	3.571 <b>.1406</b>	7.518 <b>.2960</b>	0.787 <b>.0310</b>	0.08 <b>.003</b>	3.75 <b>.148</b>	5.75 <b>.226</b>	292	97	X	X	80000	53000	
3175A	3.175 <b>.1250</b>	6.350 <b>.2500</b>	2.380 <b>.0937</b>	–	7.518 <b>.2960</b>	0.584 <b>.0230</b>	2.779 <b>.1094</b>	–	7.518 <b>.2960</b>	0.787 <b>.0310</b>	0.08 <b>.003</b>	3.75 <b>.148</b>	5.75 <b>.226</b>	311	109	X	–	80000	–	
1/8A	3.175 <b>.1250</b>	7.938 <b>.3125</b>	2.779 <b>.1094</b>	3.571 <b>.1406</b>	9.119 <b>.3590</b>	0.584 <b>.0230</b>	3.571 <b>.1406</b>	4.366 <b>.1719</b>	9.119 <b>.3590</b>	0.787 <b>.0310</b>	0.08 <b>.003</b>	3.90 <b>.154</b>	7.20 <b>.283</b>	644	215	X	X	65000	51000	
3175/061	3.175 <b>.1250</b>	9.525 <b>.3750</b>	2.779 <b>.1094</b>	–	–	–	2.779 <b>.1094</b>	–	–	–	0.08 <b>.003</b>	3.90 <b>.154</b>	8.80 <b>.346</b>	292	97	X	–	80000	–	
3175/6	3.175 <b>.1250</b>	9.525 <b>.3750</b>	–	–	–	–	2.779 <b>.1094</b>	–	–	–	0.08 <b>.003</b>	3.90 <b>.154</b>	8.80 <b>.346</b>	292	97	X	–	80000	–	
1/8A/6	3.175 <b>.1250</b>	9.525 <b>.3750</b>	–	–	–	–	3.571 <b>.1406</b>	4.366 <b>.1719</b>	10.719 <b>.4220</b>	0.787 <b>.0310</b>	0.08 <b>.003</b>	3.90 <b>.154</b>	8.80 <b>.346</b>	644	215	X	X	82000	51000	
1/8B	3.175 <b>.1250</b>	9.525 <b>.3750</b>	3.967 <b>.1562</b>	4.763 <b>.1875</b>	11.176 <b>.4400</b>	0.762 <b>.0300</b>	3.967 <b>.1562</b>	4.763 <b>.1875</b>	11.176 <b>.4400</b>	0.762 <b>.0300</b>	0.30 <b>.012</b>	4.55 <b>.179</b>	8.25 <b>.325</b>	720	260	X	X	61000	44000	
3175/552	3.175 <b>.1250</b>	10.414 <b>.4100</b>	–	–	–	–	2.380 <b>.0937</b>	–	–	–	0.08 <b>.003</b>	3.75 <b>.148</b>	8.40 <b>.331</b>	292	97	X	–	80000	–	
3175/8	3.175 <b>.1250</b>	12.700 <b>.5000</b>	–	–	–	–	2.779 <b>.1094</b>	3.571 <b>.1406</b>	–	–	0.08 <b>.003</b>	4.55 <b>.179</b>	11.35 <b>.447</b>	292	97	X	–	80000	–	
1/8B/083	3.175 <b>.1250</b>	12.700 <b>.5000</b>	4.366 <b>.1719</b>	–	–	–	4.366 <b>.1719</b>	–	–	–	0.30 <b>.012</b>	4.55 <b>.179</b>	11.35 <b>.447</b>	725	265	X	–	74000	–	

Note:

(1) r<sub>s min</sub> = minimum single bearing chamfer or maximum permissible shaft or housing fillet radius

(2) Other load ratings are possible with different ball complements and non standard retainers

(3) Different shields and seals are available

(4) Bearings also available with 1 or 2 shields/seals

(5) Limiting speed also depends on seal, material and the respective ball complement

• Bearings without shields or retainers are also available with recesses.

• Please discuss your desired design in terms of flange, extended inner ring width, shield, lubrication, and material with our Technical Application Consultants to check availability.

• Subject to change.

• Almost all bearing types can also be enhanced with GRW XTRA. Detailed information you can find on page 79 and following.

# Deep groove radial ball bearings – inch

GRW designation	Main dimensions in [mm] [inch]		Bearing without closure in [mm] [inch]				Bearing with closure in [mm] [inch]				Chamfer in [mm] [inch]	Mounting dimensions acc. to ANSI/AFBMA Std. 12.2 in [mm] [inch]		Load ratings acc. to DIN ISO <sup>(2)</sup> (max)		Closure options <sup>(3)</sup>		Max. limiting speed <sup>(5)</sup> [mm <sup>-1</sup> ]		
	d	D	Width without closure	Width with extended inner ring without closure	Flange dimensions without closure		Width with closure	Width with extended inner ring with closure	Flange dimensions with closure			$r_{s\ min}^{(1)}$	Shaft diameter $d_{\alpha\ min}$	Housing diameter $D_{\alpha\ max}$	$C$ [N]	$C_{0r}$ [N]	Shield <sup>(4)</sup>	Seal <sup>(4)</sup>	without closure or with shield	with seal
Basic symbol			B	B <sub>1</sub>	Flange diameter FD	Flange width FB	B <sub>2</sub>	B <sub>3</sub>	Flange diameter FD <sub>1</sub>	Flange width FB <sub>1</sub>										
3967/002	3.967 <b>.1562</b>	7.938 <b>.3125</b>	–	–	–	–	2.779 <b>.1094</b>	–	–	–	0.08 <b>.003</b>	4.55 <b>.179</b>	7.30 <b>.287</b>	391	165	X	–	65000	–	
3967	3.967 <b>.1562</b>	7.938 <b>.3125</b>	2.779 <b>.1094</b>	3.571 <b>.1406</b>	9.119 <b>.3590</b>	0.584 <b>.0230</b>	3.175 <b>.1250</b>	3.967 <b>.1562</b>	9.119 <b>.3590</b>	0.914 <b>.0360</b>	0.08 <b>.003</b>	4.55 <b>.179</b>	7.30 <b>.287</b>	391	165	X	X	68000	42000	
4763A/002	4.763 <b>.1875</b>	7.938 <b>.3125</b>	–	–	–	–	2.779 <b>.1094</b>	–	–	–	0.08 <b>.003</b>	5.35 <b>.211</b>	7.30 <b>.287</b>	391	165	X	–	61000	–	
4763A	4.763 <b>.1875</b>	7.938 <b>.3125</b>	2.779 <b>.1094</b>	3.571 <b>.1406</b>	9.119 <b>.3590</b>	0.584 <b>.0230</b>	3.175 <b>.1250</b>	3.967 <b>.1562</b>	9.119 <b>.3590</b>	0.914 <b>.0360</b>	0.08 <b>.003</b>	5.35 <b>.211</b>	7.30 <b>.287</b>	391	165	X	X	65000	42000	
4763A/062	4.763 <b>.1875</b>	9.525 <b>.3750</b>	2.779 <b>.1094</b>	–	–	–	2.779 <b>.1094</b>	–	–	–	0.08 <b>.003</b>	5.35 <b>.211</b>	7.30 <b>.287</b>	391	165	X	X	65000	42000	
4763B	4.763 <b>.1875</b>	9.525 <b>.3750</b>	3.175 <b>.1250</b>	3.967 <b>.1562</b>	10.719 <b>.4220</b>	0.584 <b>.0230</b>	3.175 <b>.1250</b>	3.967 <b>.1562</b>	10.719 <b>.4220</b>	0.787 <b>.0310</b>	0.08 <b>.003</b>	5.50 <b>.217</b>	8.80 <b>.346</b>	730	271	X	X	56000	41000	
4763A/082	4.763 <b>.1875</b>	12.700 <b>.5000</b>	–	–	–	–	2.779 <b>.1094</b>	3.571 <b>.1406</b>	–	–	0.08 <b>.003</b>	5.35 <b>.211</b>	8.80 <b>.346</b>	391	165	X	–	70000	–	
4763B/083	4.763 <b>.1875</b>	12.700 <b>.5000</b>	3.967 <b>.1562</b>	–	–	–	3.967 <b>.1562</b>	–	–	–	0.08 <b>.003</b>	6.20 <b>.244</b>	11.35 <b>.447</b>	730	271	X	–	56000	–	
3/16/002	4.763 <b>.1875</b>	12.700 <b>.5000</b>	–	–	–	–	3.967 <b>.1562</b>	–	–	–	0.30 <b>.012</b>	6.20 <b>.244</b>	11.35 <b>.447</b>	1339	488	X	–	50000	–	
3/16	4.763 <b>.1875</b>	12.700 <b>.5000</b>	3.967 <b>.1562</b>	4.763 <b>.1875</b>	14.351 <b>.5000</b>	1.067 <b>.0420</b>	4.978 <b>.1960</b>	5.771 <b>.2272</b>	14.351 <b>.5000</b>	1.067 <b>.0420</b>	0.30 <b>.012</b>	6.20 <b>.244</b>	11.35 <b>.447</b>	1339	488	X	X	50000	37000	
4763B/084	4.763 <b>.1875</b>	12.700 <b>.5000</b>	2.779 <b>.1094</b>	–	–	–	5.558 <b>.2188</b>	–	–	–	0.30 <b>.012</b>	6.20 <b>.244</b>	11.35 <b>.447</b>	730	271	–	–	43000	–	
1/4A/0001	4.763 <b>.1875</b>	15.875 <b>.6250</b>	4.978 <b>.1960</b>	–	17.526 <b>.6900</b>	1.067 <b>.0420</b>	4.978 <b>.196</b>	–	17.526 <b>.6900</b>	1.067 <b>.0420</b>	0.30 <b>.012</b>	6.20 <b>.244</b>	14.35 <b>.565</b>	1651	670	X	X	41000	31000	
6350A	6.350 <b>.2500</b>	9.525 <b>.3750</b>	3.175 <b>.1250</b>	3.967 <b>.1562</b>	10.719 <b>.4220</b>	0.584 <b>.02300</b>	3.175 <b>.1250</b>	3.967 <b>.1562</b>	10.719 <b>.4220</b>	0.914 <b>.0360</b>	0.08 <b>.003</b>	6.90 <b>.272</b>	8.95 <b>.352</b>	391	165	X	X	54000	35000	
6350B	6.350 <b>.2500</b>	12.700 <b>.5000</b>	3.175 <b>.1250</b>	3.967 <b>.1562</b>	13.894 <b>.5000</b>	0.584 <b>.02300</b>	4.763 <b>.1875</b>	5.558 <b>.2188</b>	13.894 <b>.5000</b>	1.143 <b>.0450</b>	0.13 <b>.005</b>	7.20 <b>.283</b>	11.85 <b>.467</b>	730	271	X	X	38000	33000	
1/4A	6.350 <b>.2500</b>	15.875 <b>.6250</b>	4.978 <b>.1960</b>	5.771 <b>.2272</b>	17.526 <b>.6900</b>	1.067 <b>.0420</b>	4.978 <b>.1960</b>	5.771 <b>.2272</b>	17.526 <b>.6900</b>	1.067 <b>.0420</b>	0.30 <b>.012</b>	7.85 <b>.309</b>	14.35 <b>.565</b>	1651	670	X	X	43000	31000	
1/4/002	6.350 <b>.2500</b>	19.050 <b>.7500</b>	–	–	–	–	5.558 <b>.2188</b>	–	–	–	0.41 <b>.016</b>	8.20 <b>.323</b>	17.20 <b>.677</b>	2522	1057	X	X	35000	28000	
1/4	6.350 <b>.2500</b>	19.050 <b>.7500</b>	5.558 <b>.2188</b>	–	–	–	7.142 <b>.2812</b>	–	–	–	0.41 <b>.016</b>	8.20 <b>.323</b>	17.20 <b>.677</b>	2522	1057	X	X	35000	28000	
7938	7.938 <b>.3125</b>	12.700 <b>.5000</b>	3.967 <b>.1562</b>	4.763 <b>.1875</b>	13.894 <b>.5000</b>	0.787 <b>.03100</b>	3.967 <b>.1562</b>	4.763 <b>.1875</b>	13.894 <b>.5000</b>	0.787 <b>.0310</b>	0.13 <b>.005</b>	8.80 <b>.346</b>	11.85 <b>.467</b>	539	279	X	X	45000	30000	

Note:

<sup>(1)</sup>  $r_{s\ min}$  = minimum single bearing chamfer or maximum permissible shaft or housing fillet radius

<sup>(2)</sup> Other load ratings are possible with different ball complements and non standard retainers

<sup>(3)</sup> Different shields and seals are available

<sup>(4)</sup> Bearings also available with 1 or 2 shields/seals

<sup>(5)</sup> Limiting speed also depends on seal, material and the respective ball complement

• Bearings without shields or retainers are also available with recesses.

• Please discuss your desired design in terms of flange, extended inner ring width, shield, lubrication, and material with our Technical Application Consultants to check availability.

• Subject to change.

• Almost all bearing types can also be enhanced with GRW XTRA. Detailed information you can find on page 79 and following.

# Deep groove radial ball bearings – inch

GRW designation	Main dimensions in [mm] [inch]		Bearing without closure in [mm] [inch]				Bearing with closure in [mm] [inch]				Chamfer in [mm] [inch]	Mounting dimensions acc. to ANSI/AFBMA Std. 12.2 in [mm] [inch]		Load ratings acc. to DIN ISO <sup>(2)</sup> (max)		Closure options <sup>(3)</sup>		Max. limiting speed <sup>(5)</sup> [mm <sup>-1</sup> ]	
	d	D	Width without closure	Width with extended inner ring without closure	Flange dimensions without closure		Width with closure	Width with extended inner ring with closure	Flange dimensions with closure			r <sub>s min</sub> <sup>(1)</sup>	Shaft diameter d <sub>a min</sub>	Housing diameter D <sub>a max</sub>	C [N]	C <sub>0r</sub> [N]	Shield <sup>(4)</sup>	Seal <sup>(4)</sup>	without closure or with shield
9525	9.525 <b>.3750</b>	15.875 <b>.6250</b>	3.967 <b>.1562</b>	–	–	–	3.967 <b>.1562</b>	–	–	–	0.25 <b>.010</b>	11.05 <b>.435</b>	14.35 <b>.565</b>	856	435	X	–	35000	–
3/8/002	9.525 <b>.3750</b>	22.225 <b>.8750</b>	–	–	–	–	5.558 <b>.2188</b>	–	–	–	0.41 <b>.016</b>	11.45 <b>.451</b>	20.30 <b>.799</b>	2555	1129	X	–	30000	–
3/8	9.525 <b>.3750</b>	22.225 <b>.8750</b>	5.558 <b>.2188</b>	–	24.613 <b>.9690</b>	1.575 <b>.0620</b>	7.142 <b>.2812</b>	–	24.613 <b>.9690</b>	1.575 <b>.0620</b>	0.41 <b>.016</b>	11.45 <b>.451</b>	20.30 <b>.799</b>	2555	1129	X	X	30000	24000
12700A/002	12.700 <b>.5000</b>	19.050 <b>.7500</b>	–	–	–	–	3.967 <b>.1562</b>	–	–	–	0.25 <b>.010</b>	14.20 <b>.500</b>	17.55 <b>.691</b>	918	542	X	X	28000	20000
12700B	12.700 <b>.5000</b>	22.225 <b>.8750</b>	7.142 <b>.2812</b>	–	–	–	7.142 <b>.2812</b>	–	–	–	0.41 <b>.016</b>	14.20 <b>.500</b>	20.30 <b>.799</b>	1972	1144	X	–	28000	–
1/2	12.700 <b>.5000</b>	28.575 <b>1.1250</b>	6.350 <b>.2500</b>	–	31.115 <b>1.2250</b>	1.575 <b>.0620</b>	7.938 <b>.3125</b>	–	31.115 <b>1.2250</b>	1.575 <b>.0620</b>	0.41 <b>.016</b>	15.90 <b>.626</b>	26.05 <b>1.026</b>	5108	2413	X	X	32000	21000
15875A	15.875 <b>.6250</b>	22.225 <b>.8750</b>	3.967 <b>.1562</b>	–	–	–	3.967 <b>.1562</b>	–	–	–	0.25 <b>.010</b>	19.05 <b>.750</b>	20.30 <b>.799</b>	1133	801	X	–	25000	–
5/8	15.875 <b>.6250</b>	34.925 <b>1.3750</b>	7.142 <b>.2812</b>	–	–	–	8.733 <b>.3438</b>	–	37.846 <b>1.4900</b>	1.745 <b>.0687</b>	0.80 <b>.031</b>	19.05 <b>.750</b>	31.75 <b>1.250</b>	5999	3265	X	–	25000	–

Note:

<sup>(1)</sup> r<sub>s min</sub> = minimum single bearing chamfer or maximum permissible shaft or housing fillet radius

<sup>(2)</sup> Other load ratings are possible with different ball complements and non standard retainers

<sup>(3)</sup> Different shields and seals are available

<sup>(4)</sup> Bearings also available with 1 or 2 shields/seals

<sup>(5)</sup> Limiting speed also depends on seal, material and the respective ball complement

• Bearings without shields or retainers are also available with recesses.

• Please discuss your desired design in terms of flange, extended inner ring width, shield, lubrication, and material with our Technical Application Consultants to check availability.

• Subject to change.

• Almost all bearing types can also be enhanced with GRW XTRA. Detailed information you can find on page 79 and following.

## Spindle / angular contact bearings

Spindle bearings are single-row angular contact bearings with a nominal contact angle of 15° (C) or 25° (E). They can be subjected to both radial and (in one direction) axial loads. The direction of the axial load is shown by a "V" marking on the outer ring. GRW spindle ball bearings are suitable for applications requiring precision while carrying high load combined with high speed.

### GRW spindle ball bearings are characterized by following properties:

- Manufactured quality of P4 (ABEC7) or better.
- Rings mostly made of corrosion-resistant SV 30 high-grade steel (other materials on request).
- Steel or ceramic balls.
- Solid retainer made from fiber-reinforced phenolic resin or special materials, for special applications, speed, etc...
- 15° (C) or 25° (E) contact angles as standard.
- Optionally, bearings can be paired with three pre-defined preload classes (L, M, S) or to a specific preload.
- Oil or grease lubrication.
- Open and shielded versions available.
- Cleanroom assembly, lubrication and packaging.



### Open spindle ball bearings

- Standard configuration has large balls for optimum utilization of bearing geometries and a solid retainer for higher bearing capacities.
- The outer ring has only one partial shoulder remaining. This partial shoulder is necessary to prevent the bearing from separation.
- Solid outer ring guided retainer with a low profile cross-section is particularly well suited for oil injection lubrication or oil mist.

### Shielded spindle bearings

- Non-contact shields do not cause any additional torque caused by the shields.
- Standard shields made of Viton (VZ) coupled with a stainless steel support shield offer excellent temperature and contamination resistance.
- A very small, closely toleranced sealing gap provides protection against dust particles.
- GRW recommends using a grease lubricant for longer life and reliability.
- Dimensionally identical to non-shielded spindle bearings but sometimes different inner geometry.
- This type of design often requires use of smaller balls that results in a lower load capacity but higher axial stiffness and speed limits (usually signified by A or B after the base type).
- Also available without shields for high-speed applications.

### Handling

- GRW recommends leaving the bearing in its airtight packaging until you are ready for assembly.
- Extreme cleanliness during assembly is recommended.
- Avoid to drop or to subject the bearing to any kind of impact loading.
- Spindle bearings are designed to withstand axial loads in only one direction. This direction is identified by the "V" laser marking on the outer ring.
- Using the proper assembly tooling will prevent damage of the bearing.
- Duplex bearings labeled (DB), (DF), or (DT) are always packed in pairs and can only be used as pair in the specified configuration.
- Universally ground duplex bearings can be used in a combination of configurations, i.e. you can combine bearings from different packages or lots. These bearings may be assembled in any duplex arrangement.
- Prior to using these bearings in application GRW has found that a run in period at high speed helps to distribute the lubricant and is beneficial for the bearing.

## Duplex bearings

Duplex bearings are two matched bearings that provide following performance benefits:

- Accurate bearing alignment in radial and axial directions including defined clearances and controlled stiffnesses.
- Increased system reliability.
- Higher load capacity.

Duplexing of these bearings is performed by loading each bearing with with a specified preload and accurately grinding the inner and/or outer rings until the bearing faces of both rings are flush.

Paired bearings processed this way are designed to be assembled in following configurations: back-to-back (DB), face-to-face (DF) or tandem (DT) and axially loaded to the specified or required force. Duplexed bearings are designed to provide the specified preload when the ground surfaces are accurately pressed together.

The ball bearings must be mounted according to the designation on the packaging labels or "V" markings on the outer rings.

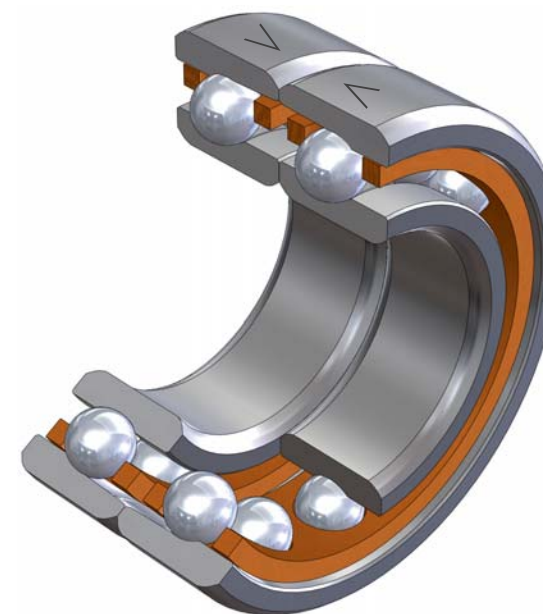

### Deep groove radial bearings:

For deep groove duplex bearings, the radial play is larger than normal to facilitate the desired contact angle, rigidity, and axial load capacity.

Unless otherwise specified, GRW duplex grinds deep groove radial bearings to a preload of 5 N and a nominal contact angle of 15°. If necessary, preload and contact angles can be adjusted to a customer's unique operating requirements.

### Spindle bearings:

Preload and contact angle are generally standardized for spindle bearings. GRW's standard contact angles are 15° (C) or 25° (E), preload is specified as light (L), medium (M) or heavy (S). If necessary, preload and contact angles can be customized to each customer's individual operating requirements.

	By default, GRW uses for:	
	Deep groove radial bearings	Spindle bearings
Contact angle $\alpha$	15° (C)	15° (C) or 25° (E)
Preload FV	5 N	L, M, S

However, the preload should not be specified higher than necessary as this would result in an increase of start up and running torque, which in turn would directly affect the expected life of the bearing.

To achieve, an identical fit for both bearings, Duplex bearings are sorted into two groups. The bore and outer diameters are packaged in pairs with bearings from the same group. To take full advantage of these duplexed pairs, they should also be mounted with calibrated shafts and housings (see chapter "Calibration of bore and outside diameters").

**Bearing fits should be carefully selected because an interference fit on the inner or outer ring will change the preload.**



# Installation and configuration of duplex bearings

## O (<>) arrangement: Back to back (designation -1 and DB for spindle bearings)

With this bearing configuration, the inner rings are designed to be clamped together. The contact angle load path between the outer ring raceway, the ball and the inner ring raceway diverge, which results in maximum stability and stiffness against any moment loading. Radial and axial loads can be taken in both directions.

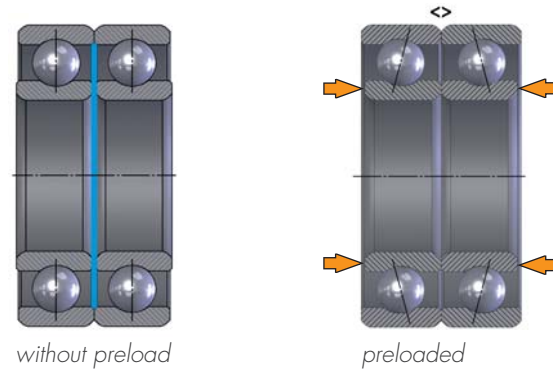

## X (><) arrangement: Face to face (designation -2 and DF for spindle bearings)

With this bearing configuration, the outer rings are designed to be clamped together. The load path converges resulting in less stability and a lower stiffness against moment loading. This design more easily compensates for any misalignment of the assembly. Radial and axial loads can likewise be taken in both directions.

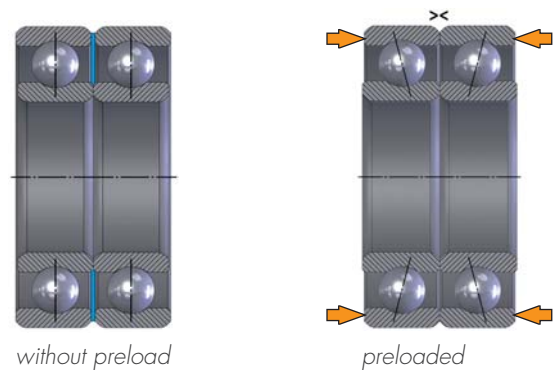

## Tandem (>>) or (<<) arrangement (designation -3 and DT for spindle bearings)

The tandem-mounted bearing design is capable of taking a significantly higher axial load, but only in one direction. With this type of bearing, preloading and control of axial play can only be achieved by preloading against another bearing pair.

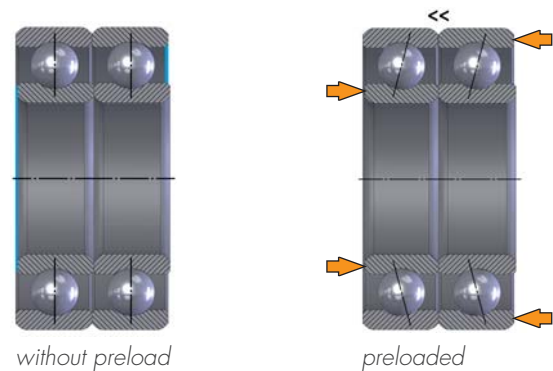

General: Bearings with these pairing configurations are packed in pairs or sets and must not be mixed.

## Universal (designation -4 and U for spindle bearings)



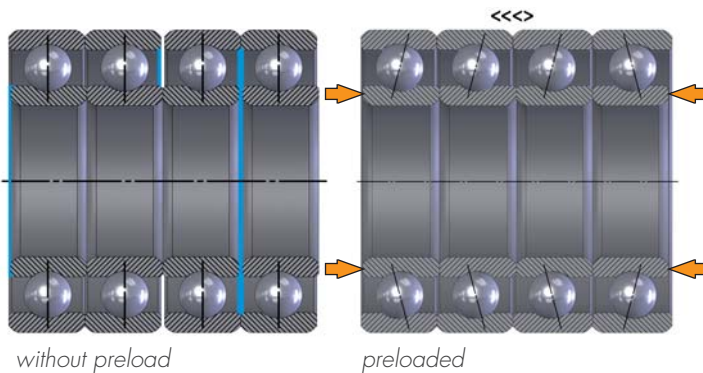

Universally matched bearing pairs have a significant advantage compared to the duplexed designs described above. They are individually ground in such a way that they can be assembled in various pairing configurations, e.g. X, O, or tandem configuration without any loss in performance. With the same preload, these single bearings can be interchanged without any problems.

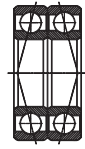
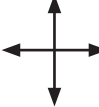
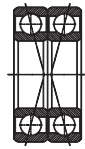
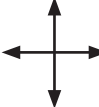

## Bearing sets

When a higher stiffness is specified, multiple duplexed bearing configurations may be used together to achieve the desired results. Depending on the application, these bearing sets can be made of universally

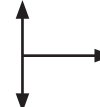
paired bearings in X, O, or tandem configurations. The table below shows some examples of potential configurations in more detail.

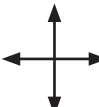
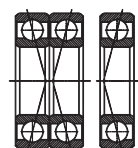
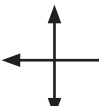
	Usual designation	Mark/ arrangement	Permissible load direction	Stiffness
	O arrangement -1 or DB	<>	 axial radial	axial radial rigidity against moving torques
	X arrangement -2 or DF	><	 axial radial	axial radial
	Tandem arrangement -3 or DT	<< or >>	 radial and one direction axially	unilaterally axial radial
	Universal -4 or U	<<<< Examples: >> or <> or >> or...	 axial radial	depending on the configuration
	Set of bearings assem- bled from universally matched bearings	>><< Examples: <>>		depending on the configuration

## Superduplex bearings

Superduplex bearings are double-row deep groove radial bearings or angular contact bearings where either the inner or outer rings are integral and the remaining rings are separate to allow for assembly and proper pre-loading. (See also chapter "Special bearings" → Superduplex bearings or Extraduplex bearings).

For Superduplex bearings, the following configurations apply:

- **Designation -5**  
O (<>) configuration (corresponds to designation -1)
- **Designation -6**  
X (><) configuration (corresponds to designation -2)
- **Designation -7**  
Tandem (corresponds to designation -3)

# Designation system for spindle ball bearings

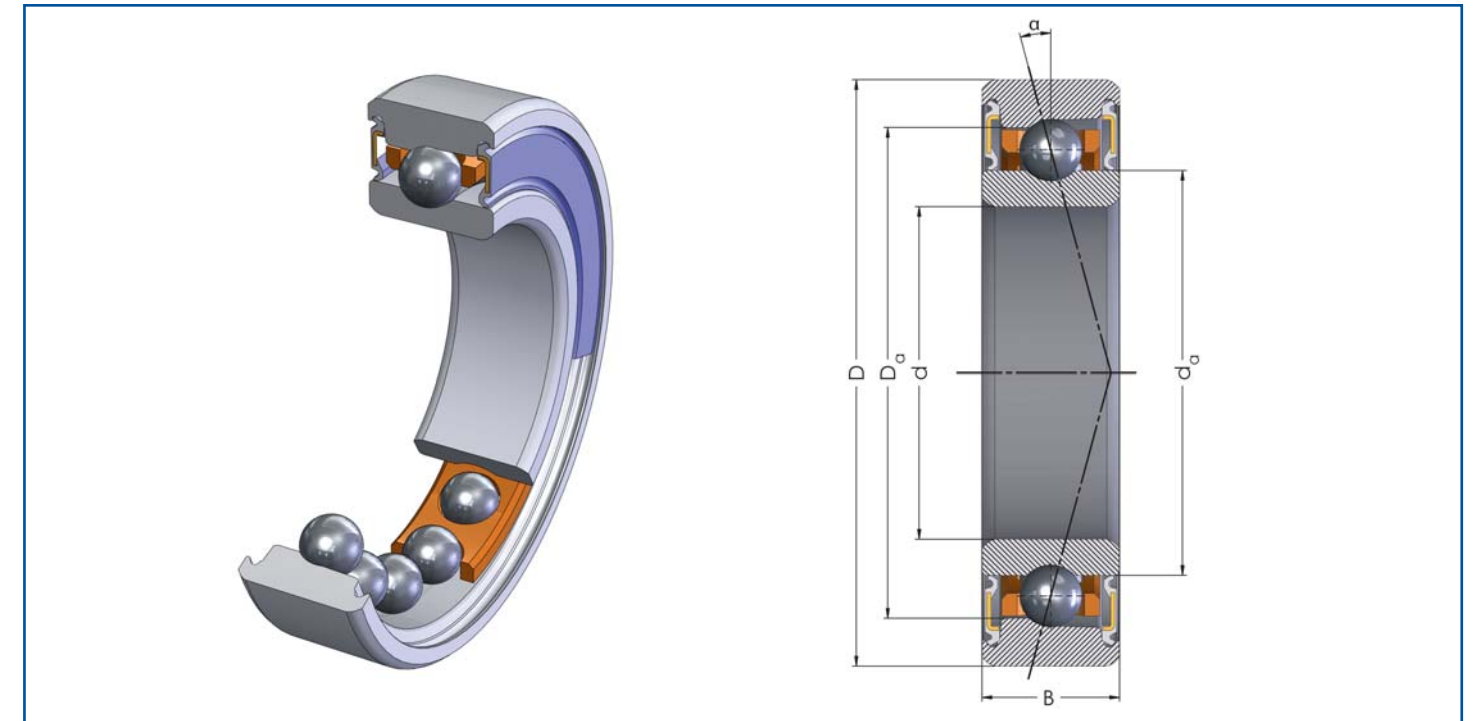
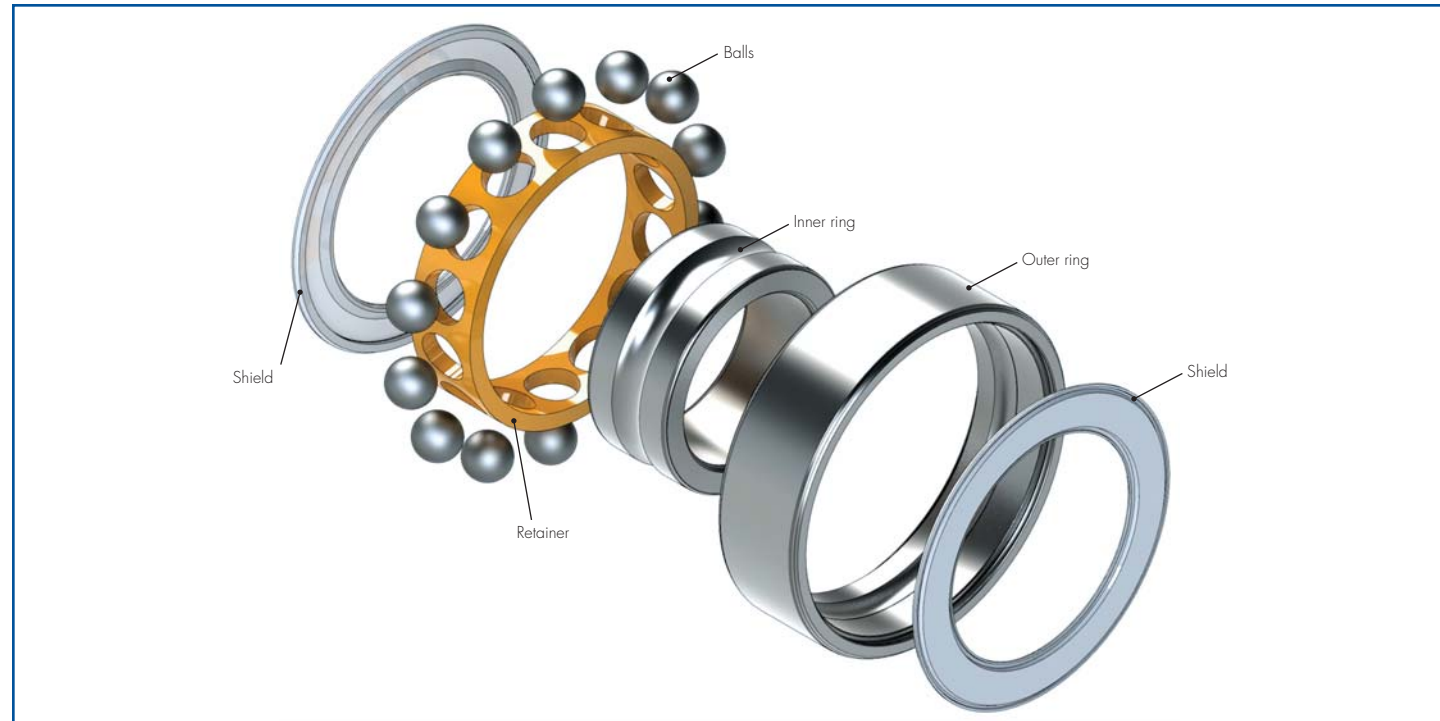

Ball material	Ring material	Basic mark	Closure	Contact angle	Quality class
-	-	705	-	C	P4
HY	SS	7000	-Z	E	P4S
ZO	SV	795	-2Z	D = ... °	
		7900	-VZ		
		705B	-2VZ		
- steel balls	- 100Cr6	70.. Series 10	- open ball bearing	C 15°	P4 acc. to DIN 620-2
HY ceramic balls made of Si <sub>3</sub> N <sub>4</sub>	SS X65Cr13	79.. Series 19	-Z one metal shield	E 25°	P4S dimension accuracy P4, running accuracy P2, acc. to DIN 620-2
ZO ceramic balls made of ZrO <sub>2</sub>	SV X30CrMoN15-1 Standard	705B Modified internal design	-2Z two metal shields -VZ one Viton shield -2VZ two Viton shields	other contact angles available on request, e.g. D = 20°	
All Variants are non-contact closures					

Retainer design	Diameter grading	Duplex type	Preload value	Lubricant quantity	Lubricants
TA	-	-	-	-	-
TB	X	U	L	... %	L...
AC2TA	XB	DB	M		G...
L2TA	XD	DF	S		L299
	X4	DT	/X		
	X4B				
	X4D				
TA solid retainer made of fiber-reinforced phenolic resin guided by outer ring	- without diameter grading	- single bearing not duplexed	- without preload	- Standard grease quantity 20 % of free bearing volume with closed spindle bearing	- open bearings are preserved with oil L001, closed bearings are greased with 20% grease
TB same as TA, with guide at inner ring	X bore and outside diameter graded in 2 classes	U universally duplexed	L light	... % adjusted lubricant quantity in [%] of free bearing volume	L... Oil
TA other retainer materials available on request	XB bore graded in 2 classes	<b>Bearing pair:</b>	S heavy		G510 as a standard
-TA angular contact shoulder on outer ring (standard)	XD outside diameter graded in 2 classes	DB 2 bearings in O arrangement	/X preload value in [N] if other than L, M, S.		L... Oil
-TB angular contact shoulder on inner ring	X4 bore and outside diameter graded in 4 classes	DF 2 bearings in X arrangement			G... Grease
AC2 angular contact shoulder on inner ring	X4B bore graded in 4 classes	DT 2 bearings in Tandem arrangement			L299 dry bearing
L2TA inner ring can be dismounted, solid retainer keeps the balls from falling out	X4D outside diameter graded in 4 classes		Example: Spindle ball bearing U/10 (= universally paired with 10 N preload)		

# Spindle bearings

GRW designation	Main dimensions in [mm]			Load ratings acc. to DIN ISO		Ball set	Limiting speeds*	Preload		
	d	D	B	C <sub>Or</sub> [N]	C <sub>r</sub> [N]			(L) light [N]	(M) medium [N]	(S) heavy [N]

## AC bearings, open, metric

SV723 C TA	<b>3.00</b> .1181	<b>10.00</b> .3937	<b>4.00</b> .1575	170	506	8	<b>1.588</b> .0625	254000	209000	5	8	16
HYSV723 C TA	<b>3.00</b> .1181	<b>10.00</b> .3937	<b>4.00</b> .1575	119	506	8	<b>1.588</b> .0625	373000	269000	5	8	16
SV774 C TA	<b>4.00</b> .1575	<b>7.00</b> .2756	<b>2.00</b> .0787	77	223	10	<b>1.000</b> .0394	309000	255000	5	7	10
HYSV774 C TA	<b>4.00</b> .1575	<b>7.00</b> .2756	<b>2.00</b> .0787	54	223	10	<b>1.000</b> .0394	455000	327000	5	7	10
SV724 C TA	<b>4.00</b> .1575	<b>13.00</b> .5118	<b>5.00</b> .1969	364	1037	8	<b>2.381</b> .0937	195000	161000	5	16	32
HYSV724 C TA	<b>4.00</b> .1575	<b>13.00</b> .5118	<b>5.00</b> .1969	255	1037	8	<b>2.381</b> .0937	287000	206000	5	16	32
SV734 C TA	<b>4.00</b> .1575	<b>16.00</b> .6299	<b>5.00</b> .1969	721	1594	9	<b>2.500</b> .0984	157000	130000	8	24	49
HYSV734 C TA	<b>4.00</b> .1575	<b>16.00</b> .6299	<b>5.00</b> .1969	504	1594	9	<b>2.500</b> .0984	231000	167000	8	24	49
SV725 C TA	<b>5.00</b> .1969	<b>16.00</b> .6299	<b>5.00</b> .1969	721	1594	9	<b>2.500</b> .0984	157000	130000	8	24	49
HYSV725 C TA	<b>5.00</b> .1969	<b>16.00</b> .6299	<b>5.00</b> .1969	504	1594	9	<b>2.500</b> .0984	231000	167000	8	24	49
SV735 C TA	<b>5.00</b> .1969	<b>19.00</b> .7480	<b>6.00</b> .2362	1277	2612	10	<b>3.175</b> .1250	127000	105000	13	40	80
HYSV735 C TA	<b>5.00</b> .1969	<b>19.00</b> .7480	<b>6.00</b> .2362	894	2612	10	<b>3.175</b> .1250	187000	135000	13	40	80
SV786 C TA	<b>6.00</b> .2362	<b>13.00</b> .5118	<b>3.50</b> .1378	354	895	10	<b>1.984</b> .0781	175000	144000	5	14	28
HYSV786 C TA	<b>6.00</b> .2362	<b>13</b> .5118	<b>3.50</b> .1378	247	895	10	<b>1.984</b> .0781	258000	186000	5	14	28
SV786 E TA	<b>6.00</b> .2362	<b>13.00</b> .5118	<b>3.50</b> .1378	332	856	10	<b>1.984</b> .0781	149000	123000	5	14	28
HYSV786 E TA	<b>6.00</b> .2362	<b>13.00</b> .5118	<b>3.50</b> .1378	232	856	10	<b>1.984</b> .0781	219000	158000	5	14	28
SV786/001 C TA	<b>6.00</b> .2362	<b>13.00</b> .5118	<b>5.00</b> .1969	354	895	10	<b>1.984</b> .0781	175000	144000	5	14	28
HYSV786/001 C TA	<b>6.00</b> .2362	<b>13.00</b> .5118	<b>5.00</b> .1969	247	895	10	<b>1.984</b> .0781	258000	186000	5	14	28
SV726 C TA	<b>6.00</b> .2362	<b>19.00</b> .7480	<b>6.00</b> .2362	1277	2612	10	<b>3.175</b> .1250	127000	105000	13	40	80
HYSV726 C TA	<b>6.00</b> .2362	<b>19.00</b> .7480	<b>6.00</b> .2362	894	2612	10	<b>3.175</b> .1250	187000	135000	13	40	80
SV707 C TA	<b>7.00</b> .2756	<b>19.00</b> .7480	<b>6.00</b> .2362	1277	2612	10	<b>3.175</b> .1250	127000	105000	13	40	80
HYSV707 C TA	<b>7.00</b> .2756	<b>19.00</b> .7480	<b>6.00</b> .2362	894	2612	10	<b>3.175</b> .1250	187000	135000	13	40	80
SV727 C TA	<b>7.00</b> .2756	<b>22.00</b> .8661	<b>7.00</b> .2756	1693	3511	9	<b>3.969</b> .1563	116000	95000	18	54	108
HYSV727 C TA	<b>7.00</b> .2756	<b>22.00</b> .8661	<b>7.00</b> .2756	1185	3511	9	<b>3.969</b> .1563	170000	122000	18	54	108
SV788 C TA	<b>8.00</b> .3150	<b>16.00</b> .6299	<b>4.00</b> .1575	569	1377	10	<b>2.500</b> .0984	142000	117000	7	21	42

GRW designation	Main dimensions in [mm]			Load ratings acc. to DIN ISO		Ball set	Limiting speeds*	Preload		
	d	D	B	C <sub>Or</sub> [N]	C <sub>r</sub> [N]			(L) light [N]	(M) medium [N]	(S) heavy [N]

## AC bearings, open, metric

HYSV788 C TA	<b>8.00</b> .3150	<b>16.00</b> .6299	<b>4.00</b> .1575	398	1377	10	<b>2.500</b> .0984	208000	150000	7	21	42
SV788 E TA	<b>8.00</b> .3150	<b>16.00</b> .6299	<b>4.00</b> .1575	534	1317	10	<b>2.500</b> .0984	120000	99000	7	21	42
HYSV788 E TA	<b>8.00</b> .3150	<b>16.00</b> .6299	<b>4.00</b> .1575	374	1317	10	<b>2.500</b> .0984	177000	128000	7	21	42
SV708 C TA	<b>8.00</b> .3150	<b>22.00</b> .8661	<b>7.00</b> .2756	1693	3511	9	<b>3.969</b> .1563	116000	95000	18	54	108
HYSV708 C TA	<b>8.00</b> .3150	<b>22.00</b> .8661	<b>7.00</b> .2756	1185	3511	9	<b>3.969</b> .1563	170000	122000	18	54	108
SV708 E TA	<b>8.00</b> .3150	<b>22.00</b> .8661	<b>7.00</b> .2756	1589	3358	9	<b>3.969</b> .1563	98000	81000	18	54	108
HYSV708 E TA	<b>8.00</b> .3150	<b>22.00</b> .8661	<b>7.00</b> .2756	1112	3358	9	<b>3.969</b> .1563	145000	104000	18	54	108
SV789 C TA	<b>9.00</b> .3543	<b>17.00</b> .6693	<b>4.00</b> .1575	642	1471	11	<b>2.500</b> .0984	131000	108000	8	23	45
HYSV789 C TA	<b>9.00</b> .3543	<b>17.00</b> .6693	<b>4.00</b> .1575	450	1471	11	<b>2.500</b> .0984	192000	138000	8	23	45
SV709 C TA	<b>9.00</b> .3543	<b>24.00</b> .9449	<b>7.00</b> .2756	1974	3844	10	<b>3.969</b> .1563	105000	86000	20	59	118
HYSV709 C TA	<b>9.00</b> .3543	<b>24.00</b> .9449	<b>7.00</b> .2756	1382	3844	10	<b>3.969</b> .1563	154000	111000	20	59	118
SV729 C TA	<b>9.00</b> .3543	<b>26.00</b> 1.0236	<b>8.00</b> .3150	2737	5137	10	<b>4.763</b> .1875	94000	78000	26	79	158
HYSV729 C TA	<b>9.00</b> .3543	<b>26.00</b> 1.0236	<b>8.00</b> .3150	1916	5137	10	<b>4.763</b> .1875	139000	100000	26	79	158
SV780 C TA	<b>10.00</b> .3937	<b>19.00</b> .7480	<b>5.00</b> .1969	724	1556	12	<b>2.500</b> .0984	117000	97000	8	24	48
HYSV780 C TA	<b>10.00</b> .3937	<b>19.00</b> .7480	<b>5.00</b> .1969	507	1556	12	<b>2.500</b> .0984	172000	124000	8	24	48
SV780 E TA	<b>10.00</b> .3937	<b>19.00</b> .7480	<b>5.00</b> .1969	680	1488	12	<b>2.500</b> .0984	100000	82000	8	24	48
HYSV780 E TA	<b>10.00</b> .3937	<b>19.00</b> .7480	<b>5.00</b> .1969	476	1488	12	<b>2.500</b> .0984	147000	106000	8	24	48
SV7900 C TA	<b>10.00</b> .3937	<b>22.00</b> .8661	<b>6.00</b> .2362	1500	2824	11	<b>3.175</b> .1250	107000	88000	15	44	88
HYSV7900 C TA	<b>10.00</b> .3937	<b>22.00</b> .8661	<b>6.00</b> .2362	1050	2824	11	<b>3.175</b> .1250	157000	113000	15	44	88
SV7900A E TA	<b>10.00</b> .3937	<b>22.00</b> .8661	<b>6.00</b> .2362	1407	2700	11	<b>3.175</b> .1250	90000	74000	15	44	88
HYSV7900A E TA	<b>10.00</b> .3937	<b>22.00</b> .8661	<b>6.00</b> .2362	985	2700	11	<b>3.175</b> .1250	133000	96000	15	44	88
SV7000 C TA	<b>10.00</b> .3937	<b>26.00</b> 1.0236	<b>8.00</b> .3150	2737	5137	10	<b>4.763</b> .1875	94000	78000	26	79	158
HYSV7000 C TA	<b>10.00</b> .3937	<b>26.00</b> 1.0236	<b>8.00</b> .3150	1916	5137	10	<b>4.763</b> .1875	139000	100000	26	79	158

\* The indicated speed limits are guidelines for spring-loaded single bearings with low loads; depending on the respective application, higher or lower speed limits may apply in application.

\*\* For use with oil lubrication, these bearings are also available without shields. Almost all bearing types can also be enhanced with GRW XTRA. Detailed information you can find on page 79 and following.

• Subject to change. Additional types on request!

# Spindle bearings

GRW designation	Main dimensions in [mm]			Load ratings acc. to DIN ISO		Ball set	Limiting speeds*			Preload		
	d	D	B	C <sub>0r</sub> [N]	C <sub>r</sub> [N]		Oil [min <sup>-1</sup> ]	Grease [min <sup>-1</sup> ]	(L) light [N]	(M) medium [N]	(S) heavy [N]	

## AC bearings, open, metric

SV7000 E TA	10.00 .3937	26.00 1.0236	8.00 .3150	2568	4913	10	4.763 .1875	80000	66000	26	79	158
HYSV7000 E TA	10.00 .3937	26.00 1.0236	8.00 .3150	1798	4913	10	4.763 .1875	118000	85000	26	79	158
SV7200 C TA	10.00 .3937	30.00 1.1811	9.00 .3543	3192	5597	11	4.763 .1875	83000	68000	29	86	172
HYSV7200 C TA	10.00 .3937	30.00 1.1811	9.00 .3543	2235	5597	11	4.763 .1875	122000	88000	29	86	172
SV7200 E TA	10.00 .3937	30.00 1.1811	9.00 .3543	2995	5353	11	4.763 .1875	71000	58000	29	86	172
HYSV7200 E TA	10.00 .3937	30.00 1.1811	9.00 .3543	2097	5353	11	4.763 .1875	104000	75000	29	86	172
SV7801 C TA	12.00 .4724	21.00 .8268	5.00 .1969	794	1543	14	2.381 .0937	103000	84000	8	24	48
HYSV7801 C TA	12.00 .4724	21.00 .8268	5.00 .1969	556	1543	14	2.381 .0937	151000	109000	8	24	48
SV7801 E TA	12.00 .4724	21.00 .8268	5.00 .1969	745	1476	14	2.381 .0937	87000	72000	8	24	48
HYSV7801 E TA	12.00 .4724	21.00 .8268	5.00 .1969	521	1476	14	2.381 .0937	128000	92000	8	24	48
SV7901 C TA	12.00 .4724	24.00 .9449	6.00 .2362	1700	2992	12	3.175 .1250	94000	78000	15	46	92
HYSV7901 C TA	12.00 .4724	24.00 .9449	6.00 .2362	1190	2992	12	3.175 .1250	139000	100000	15	46	92
SV7901 E TA	12.00 .4724	24.00 .9449	6.00 .2362	1595	2861	12	3.175 .1250	80000	66000	15	46	92
HYSV7901 E TA	12.00 .4724	24.00 .9449	6.00 .2362	1117	2861	12	3.175 .1250	118000	85000	15	46	92
SV7001 C TA	12.00 .4724	28.00 1.1024	8.00 .3150	2590	4423	12	3.969 .1563	82000	68000	23	68	136
HYSV7001 C TA	12.00 .4724	28.00 1.1024	8.00 .3150	1813	4423	12	3.969 .1563	121000	87000	23	68	136
SV7001 E TA	12.00 .4724	28.00 1.1024	8.00 .3150	2430	4230	12	3.969 .1563	70000	58000	23	68	136
HYSV7001 E TA	12.00 .4724	28.00 1.1024	8.00 .3150	1701	4230	12	3.969 .1563	103000	74000	23	68	136
SV7201C C TA	12.00 .4724	32.00 1.2598	10.00 .3937	3806	7652	9	5.953 .2344	77000	64000	39	118	235
HYSV7201C C TA	12.00 .4724	32.00 1.2598	10.00 .3937	2664	7652	9	5.953 .2344	114000	82000	39	118	235
SV7201C E TA	12.00 .4724	32.00 1.2598	10.00 .3937	3571	7318	9	5.953 .2344	66000	54000	39	118	235
HYSV7201C E TA	12.00 .4724	32.00 1.2598	10.00 .3937	2500	7318	9	5.953 .2344	97000	70000	39	118	235
SV7802 C TA	15.00 .5906	24.00 .9449	5.00 .1969	1054	1784	18	2.381 .0937	87000	72000	9	27	55
HYSV7802 C TA	15.00 .5906	24.00 .9449	5.00 .1969	738	1784	18	2.381 .0937	128000	92000	9	27	55
SV7802 E TA	15.00 .5906	24.00 .9449	5.00 .1969	989	1706	18	2.381 .0937	74000	61000	9	27	55

GRW designation	Main dimensions in [mm]			Load ratings acc. to DIN ISO		Ball set	Limiting speeds*			Preload		
	d	D	B	C <sub>0r</sub> [N]	C <sub>r</sub> [N]		Oil [min <sup>-1</sup> ]	Grease [min <sup>-1</sup> ]	(L) light [N]	(M) medium [N]	(S) heavy [N]	

## AC bearings, open, metric

HYSV7802 E TA	15.00 .5906	24.00 .9449	5.00 .1969	692	1706	18	2.381 .0937	109000	78000	9	27	55
SV7902 C TA	15.00 .5906	28.00 1.1024	7.00 .2756	2841	4666	13	3.969 .1563	79000	65000	24	72	143
HYSV7902 C TA	15.00 .5906	28.00 1.1024	7.00 .2756	1989	4666	13	3.969 .1563	116000	84000	24	72	143
SV7902 E TA	15.00 .5906	28.00 1.1024	7.00 .2756	2665	4463	13	3.969 .1563	67000	55000	24	72	143
HYSV7902 E TA	15.00 .5906	28.00 1.1024	7.00 .2756	1866	4463	13	3.969 .1563	99000	71000	24	72	143
SV7002 C TA	15.00 .5906	32.00 1.2598	9.00 .3543	3970	6327	13	4.763 .1875	72000	60000	32	97	194
HYSV7002 C TA	15.00 .5906	32.00 1.2598	9.00 .3543	2779	6327	13	4.763 .1875	106000	77000	32	97	194
SV7002 E TA	15.00 .5906	32.00 1.2598	9.00 .3543	3725	6051	13	4.763 .1875	62000	51000	32	97	194
HYSV7002 E TA	15.00 .5906	32.00 1.2598	9.00 .3543	2607	6051	13	4.763 .1875	90000	65000	32	97	194
SV7202 C TA	15.00 .5906	35.00 1.3780	11.00 .4331	4090	6970	13	4.763 .1875	97000	63000	30	60	120
SV7202 E TA	15.00 .5906	35.00 1.3780	11.00 .4331	3930	6650	13	4.763 .1875	85000	55000	45	90	180
SV7803 C TA	17.00 .6693	26.00 1.0236	5.00 .1969	1071	1754	18	2.381 .0937	79000	65000	9	27	54
HYSV7803 C TA	17.00 .6693	26.00 1.0236	5.00 .1969	750	1754	18	2.381 .0937	116000	84000	9	27	54
SV7803 E TA	17.00 .6693	26.00 1.0236	5.00 .1969	1005	1677	18	2.381 .0937	67000	55000	9	27	54
HYSV7803 E TA	17.00 .6693	26.00 1.0236	5.00 .1969	704	1677	18	2.381 .0937	99000	71000	9	27	54
SV7903 C TA	17.00 .6693	30.00 1.1811	7.00 .2756	3137	4888	14	3.969 .1563	72000	60000	25	75	150
HYSV7903 C TA	17.00 .6693	30.00 1.1811	7.00 .2756	2196	4888	14	3.969 .1563	106000	77000	25	75	150
SV7903 E TA	17.00 .6693	30.00 1.1811	7.00 .2756	2944	4675	14	3.969 .1563	61000	51000	25	75	150
HYSV7903 E TA	17.00 .6693	30.00 1.1811	7.00 .2756	2061	4675	14	3.969 .1563	90000	65000	25	75	150
SV7003 C TA	17.00 .6693	35.00 1.3780	10.00 .3937	4571	6817	14	4.763 .1875	65000	54000	34	102	205
HYSV7003 C TA	17.00 .6693	35.00 1.3780	10.00 .3937	3200	6817	14	4.763 .1875	96000	69000	34	102	205
SV7003 E TA	17.00 .6693	35.00 1.3780	10.00 .3937	4571	6817	14	4.763 .1875	56000	46000	34	102	205
HYSV7003 E TA	17.00 .6693	35.00 1.3780	10.00 .3937	3200	6817	14	4.763 .1875	82000	59000	34	102	205

\* The indicated speed limits are guidelines for spring-loaded single bearings with low loads; depending on the respective application, higher or lower speed limits may apply in application.

• Subject to change. Additional types on request!

\*\* For use with oil lubrication, these bearings are also available without shields. • Almost all bearing types can also be enhanced with GRW XTRA. Detailed information you can find on page 79 and following.

# Spindle bearings

GRW designation	Main dimensions in [mm]			Load ratings acc. to DIN ISO		Ball set	Limiting speeds*		Preload		
	d	D	B	C <sub>0r</sub> [N]	C <sub>r</sub> [N]		Oil [min <sup>-1</sup> ]	Grease [min <sup>-1</sup> ]	(L) light [N]	(M) medium [N]	(S) heavy [N]

## AC bearings, open, metric

SV7203 C TA	17.00 .6693	40.00 1.5748	12.00 .4724	5090	8730	12	5.556 .2187	85000	55000	35	70	140
SV7203 E TA	17.00 .6693	40.00 1.5748	12.00 .4724	4860	8340	12	5.556 .2187	75000	49000	60	120	240
SV7804 C TA	20.00 .7874	32.00 1.2598	7.00 .2756	2772	3772	18	3.175 .1250	65000	54000	19	58	115
HYSV7804 C TA	20.00 .7874	32.00 1.2598	7.00 .2756	1941	3772	18	3.175 .1250	96000	69000	19	58	115
SV7804 E TA	20.00 .7874	32.00 1.2598	7.00 .2756	2870	3865	18	3.175 .1250	56000	46000	19	58	115
HYSV7804 E TA	20.00 .7874	32.00 1.2598	7.00 .2756	2009	3772	18	3.175 .1250	82000	59000	19	58	115
SV7904 C TA	20.00 .7874	37.00 1.4567	9.00 .3543	4854	7543	15	4.763 .1875	60000	49000	39	116	232
HYSV7904 C TA	20.00 .7874	37.00 1.4567	9.00 .3543	3398	7543	15	4.763 .1875	88000	63000	39	116	232
SV7904 E TA	20.00 .7874	37.00 1.4567	9.00 .3543	4554	7214	15	4.763 .1875	51000	42000	39	116	232
HYSV7904 E TA	20.00 .7874	37.00 1.4567	9.00 .3543	3188	7214	15	4.763 .1875	75000	54000	39	116	232
SV7004 C TA	20.00 .7874	42.00 1.6535	12.00 .4724	6090	9660	14	5.556 .2187	75000	49000	35	70	140
SV7004 E TA	20.00 .7874	42.00 1.6535	12.00 .4724	5810	9210	14	5.556 .2187	66000	43000	55	110	220
SV7204 C TA	20.00 .7874	47.00 1.8504	14.00 .5512	7320	11700	13	6.350 .2500	72000	47000	45	90	180
SV7204 E TA	20.00 .7874	47.00 1.8504	14.00 .5512	7010	11100	13	6.350 .2500	63000	41000	70	140	280
SV7805 C TA	25.00 .9843	37.00 1.4567	7.00 .2756	2335	3397	19	3.175 .1250	55000	45000	17	52	104
HYSV7805 C TA	25.00 .9843	37.00 1.4567	7.00 .2756	1634	3397	19	3.175 .1250	81000	58000	17	52	104
SV7005 C TA	25.00 .9843	47.00 1.8504	12.00 .4724	6918	11769	12	6.747 .2656	47000	39000	59	177	353
HYSV7005 C TA	25.00 .9843	47.00 1.8504	12.00 .4724	4843	11769	12	6.747 .2656	69000	50000	59	177	353
SV7005 E TA	25.00 .9843	47.00 1.8504	12.00 .4724	6890	9920	16	5.556 .2187	57000	37000	55	110	220
(SV)7205 C TA	25.00 .9843	52.00 2.0472	15.00 .5906	8710	12800	15	6.350 .2500	63000	41000	50	100	200
(SV)7205 E TA	25.00 .9843	52.00 2.0472	15.00 .5906	8330	12100	15	6.350 .2500	55000	36000	80	160	320
(SV)7006 C TA	30.00 1.1811	55.00 2.1654	13.00 .5118	9010	12100	17	5.953 .2344	55000	36000	40	80	160
(SV)7006 E TA	30.00 1.1811	55.00 2.1654	13.00 .5118	8560	11500	17	5.953 .2344	48000	31000	65	130	260

GRW designation	Main dimensions in [mm]			Load ratings acc. to DIN ISO		Ball set	Limiting speeds*		Preload		
	d	D	B	C <sub>0r</sub> [N]	C <sub>r</sub> [N]		Oil [min <sup>-1</sup> ]	Grease [min <sup>-1</sup> ]	(L) light [N]	(M) medium [N]	(S) heavy [N]

## AC bearings, open, inch

SV3/16 C TA	4.763 .1875	12.700 .5000	3.967 .1562	312	913	8	2.381 .0937	195000	161000	5	14	28
HYSV3/16 C TA	4.763 .1875	12.700 .5000	3.967 .1562	218	913	8	2.381 .0937	287000	206000	5	14	28
SV3/16 D TA	4.764 .1876	12.800 .5039	3.967 .1562	293	873	8	2.381 .0937	166000	136000	5	14	28
HYSV3/16 D TA	4.765 .1876	12.900 .5079	3.967 .1562	205	873	8	2.381 .0937	244000	175000	5	14	28
SV1/4A C TA	6.350 .2500	15.875 .6250	4.978 .1960	421	1114	9	2.500 .0984	153000	126000	6	17	34
HYSV1/4A C TA	6.350 .2500	15.875 .6250	4.978 .1960	295	1114	9	2.500 .0984	225000	162000	6	17	34
SV1/2/001 C TA	12.700 .5000	28.575 1.1250	7.938 .3125	2063	4066	12	3.969 .1563	82000	68000	20	61	121
HYSV1/2/001 C TA	12.700 .5000	28.575 1.1250	7.938 .3125	1444	4066	12	3.969 .1563	121000	87000	20	61	121

## AC bearings, dismountable, metric and inch

SV784 D L2T	4.00 .1575	9.00 .3543	2.50 .0984	132	457	7	1.588 .0625	242000	199000	5	8	15
HYSV784 D L2T	4.00 .1575	9.00 .3543	2.50 .0984	94	457	7	1.588 .0625	355000	256000	5	8	15
SV725 C L2T	5.00 .1969	16.00 .6299	5.00 .1969	737	1626	9	2.500 .0984	157000	130000	8	24	49
HYSV725 C L2T	5.00 .1969	16.00 .6299	5.00 .1969	515	1626	9	2.500 .0984	231000	167000	8	24	49
SV725 D L2T	5.00 .1969	16.00 .6299	5.00 .1969	737	1626	9	2.500 .0984	134000	110000	8	24	49
HYSV725 D L2T	5.00 .1969	16.00 .6299	5.00 .1969	515	1626	9	2.500 .0984	197000	142000	8	24	49
SV707 C L2T	7.00 .2756	19.00 .7480	6.00 .2362	1183	2617	10	3.175 .1250	127000	105000	13	40	80
HYSV707 C L2T	7.00 .2756	19.00 .7480	6.00 .2362	828	2617	10	3.175 .1250	187000	135000	13	40	80
SV7000 C L2T	10.00 .3937	26.00 1.0236	8.00 .3150	2550	4906	10	4.763 .1875	94000	78000	28	85	170
HYSV7000 C L2T	10.00 .3937	26.00 1.0236	8.00 .3150	1785	4906	10	4.763 .1875	139000	100000	28	85	170
SV1/8A D20 L2T	3.175 .1250	7.938 .3125	2.779 .1094	207	609	7	1.588 .0625	266000	219000	5	8	16
HYSV1/8A D20 L2T	3.175 .1250	7.938 .3125	2.779 .1094	144	609	7	1.588 .0625	392000	282000	5	8	16
SV1/8B D20 L2T	3.175 .1250	9.525 .3750	3.967 .1562	134	461	8	1.588 .0625	228000	188000	5	10	20
HYSV1/8B D20 L2T	3.175 .1250	9.525 .3750	3.967 .1562	95	461	8	1.588 .0625	336000	242000	5	10	20

\* The indicated speed limits are guidelines for spring-loaded single bearings with low loads; depending on the respective application, higher or lower speed limits may apply in application.

• Subject to change. Additional types on request!

\*\* For use with oil lubrication, these bearings are also available without shields. • Almost all bearing types can also be enhanced with GRW XTRA. Detailed information you can find on page 79 and following.

# Spindle bearings

GRW designation	Main dimensions in [mm] [inch]			Load ratings acc. to DIN ISO		Ball set	Limiting speeds*			Preload		
	d	D	B	C <sub>0r</sub> [N]	C <sub>r</sub> [N]		Z	D <sub>w</sub> [mm] [inch]	Oil [min <sup>-1</sup> ]	Grease [min <sup>-1</sup> ]	(L) light [N]	(M) medium [N]

## AC bearings, sealed, metric

SV725A-2VZ C TA	<b>5.00</b> .1969	<b>16.00</b> .6299	<b>5.00</b> .1969	647	1305	12	<b>1.984</b> .0781	194000**	155000	7	20	40
HYSV725A-2VZ C TA	<b>5.00</b> .1969	<b>16.00</b> .6299	<b>5.00</b> .1969	453	1305	12	<b>1.984</b> .0781	290000**	194000	7	20	40
SV725A-2VZ E TA	<b>5.00</b> .1969	<b>16.00</b> .6299	<b>5.00</b> .1969	607	1248	12	<b>1.984</b> .0781	165000**	132000	7	20	40
SV788B-2VZ C TA	<b>8.00</b> .3150	<b>16.00</b> .6299	<b>4.00</b> .1575	723	1374	13	<b>1.984</b> .0781	174000**	139000	7	21	42
HYSV788B-2VZ C TA	<b>8.00</b> .3150	<b>16.00</b> .6299	<b>4.00</b> .1575	506	1374	13	<b>1.984</b> .0781	261000**	174000	7	21	42
SV708B-2VZ C TA	<b>8.00</b> .3150	<b>22.00</b> .8661	<b>7.00</b> .2756	1298	2625	10	<b>3.175</b> .1250	144000**	115000	13	40	80
HYSV708B-2VZ C TA	<b>8.00</b> .3150	<b>22.00</b> .8661	<b>7.00</b> .2756	909	2625	10	<b>3.175</b> .1250	216000**	144000	13	40	80
SV708B-2VZ E TA	<b>8.00</b> .3150	<b>22.00</b> .8661	<b>7.00</b> .2756	1218	2510	10	<b>3.175</b> .1250	122000**	98000	13	40	80
HYSV708B-2VZ E TA	<b>8.00</b> .3150	<b>22.00</b> .8661	<b>7.00</b> .2756	853	2510	10	<b>3.175</b> .1250	183000**	122000	13	40	80
SV709A-2VZ C TA	<b>9.00</b> .3543	<b>24.00</b> .9449	<b>7.00</b> .2756	1493	2822	11	<b>3.175</b> .1250	128000**	102000	14	43	86
HYSV709A-2VZ C TA	<b>9.00</b> .3543	<b>24.00</b> .9449	<b>7.00</b> .2756	1045	2822	11	<b>3.175</b> .1250	191000**	128000	14	43	86
SV7800A-2VZ C TA	<b>10.00</b> .3937	<b>19.00</b> .7480	<b>5.00</b> .1969	876	1487	15	<b>1.984</b> .0781	143000**	114000	8	23	46
HYSV7800A-2VZ C TA	<b>10.00</b> .3937	<b>19.00</b> .7480	<b>5.00</b> .1969	613	1487	15	<b>1.984</b> .0781	215000**	143000	8	23	46
SV7900B-2VZ C TA	<b>10.00</b> .3937	<b>22.00</b> .8661	<b>6.00</b> .2362	1173	2047	13	<b>2.500</b> .0984	128000**	102000	11	33	66
HYSV7900B-2VZ C TA	<b>10.00</b> .3937	<b>22.00</b> .8661	<b>6.00</b> .2362	821	2047	13	<b>2.500</b> .0984	192000**	128000	11	33	66
SV7000A-2VZ C TA	<b>10.00</b> .3937	<b>26.00</b> 1.0236	<b>8.00</b> .3150	2030	3879	10	<b>3.969</b> .1563	115000**	92000	20	60	120
SV7000A-2VZ E TA	<b>10.00</b> .3937	<b>26.00</b> 1.0236	<b>8.00</b> .3150	1905	3710	10	<b>3.969</b> .1563	98000**	78000	20	60	120
HYSV7000A-2VZ E TA	<b>10.00</b> .3937	<b>26.00</b> 1.0236	<b>8.00</b> .3150	1334	3710	10	<b>3.969</b> .1563	147000**	98000	20	60	120
SV7901A-2VZ C TA	<b>12.00</b> .4724	<b>24.00</b> .9449	<b>6.00</b> .2362	1478	2329	16	<b>2.500</b> .0984	115000**	92000	12	35	71
HYSV7901A-2VZ C TA	<b>12.00</b> .4724	<b>24.00</b> .9449	<b>6.00</b> .2362	1035	2329	16	<b>2.500</b> .0984	173000**	115000	12	35	71
SV7901A-2VZ E TA	<b>12.00</b> .4724	<b>24.00</b> .9449	<b>6.00</b> .2362	1387	2227	16	<b>2.500</b> .0984	98000**	79000	12	35	71
HYSV7901A-2VZ E TA	<b>12.00</b> .4724	<b>24.00</b> .9449	<b>6.00</b> .2362	971	2227	16	<b>2.500</b> .0984	147000**	98000	12	35	71
SV7001B-2VZ C TA	<b>12.00</b> .4724	<b>28.00</b> 1.1024	<b>8.00</b> .3150	2328	3603	16	<b>3.175</b> .1250	101000**	80000	18	55	111
HYSV7001B-2VZ C TA	<b>12.00</b> .4724	<b>28.00</b> 1.1024	<b>8.00</b> .3150	1141	3603	16	<b>3.175</b> .1250	151000**	101000	18	55	111
SV7001B-2VZ E TA	<b>12.00</b> .4724	<b>28.00</b> 1.1024	<b>8.00</b> .3150	2184	3446	16	<b>3.175</b> .1250	85000**	68000	18	55	111

GRW designation	Main dimensions in [mm] [inch]			Load ratings acc. to DIN ISO		Ball set	Limiting speeds*			Preload		
	d	D	B	C <sub>0r</sub> [N]	C <sub>r</sub> [N]		Z	D <sub>w</sub> [mm] [inch]	Oil [min <sup>-1</sup> ]	Grease [min <sup>-1</sup> ]	(L) light [N]	(M) medium [N]

## AC bearings, sealed, metric

HYSV7001B-2VZ E TA	<b>12.00</b> .4724	<b>28.00</b> 1.1024	<b>8.00</b> .3150	1070	3446	16	<b>3.175</b> .1250	128000**	85000	18	55	111
SV7201B-2VZ E TA	<b>12.00</b> .4724	<b>32.00</b> 1.2598	<b>10.00</b> .3937	3034	5373	11	<b>4.763</b> .1875	80000**	64000	29	86	173
HYSV7201B-2VZ E TA	<b>12.00</b> .4724	<b>32.00</b> 1.2598	<b>10.00</b> .3937	1487	5373	11	<b>4.763</b> .1875	120000**	80000	29	86	173
SV7902A-2VZ C TA	<b>15.00</b> .5906	<b>28.00</b> 1.1024	<b>7.00</b> .2756	2359	3586	16	<b>3.175</b> .1250	95000**	76000	18	55	110
HYSV7902A-2VZ C TA	<b>15.00</b> .5906	<b>28.00</b> 1.1024	<b>7.00</b> .2756	1651	3586	16	<b>3.175</b> .1250	143000**	95000	18	55	110
SV7902A-2VZ E TA	<b>15.00</b> .5906	<b>28.00</b> 1.1024	<b>7.00</b> .2756	2213	3430	16	<b>3.175</b> .1250	81000**	65000	18	55	110
HYSV7902A-2VZ E TA	<b>15.00</b> .5906	<b>28.00</b> 1.1024	<b>7.00</b> .2756	1549	3430	16	<b>3.175</b> .1250	121000**	81000	18	55	110
SV7002A-2VZ C TA	<b>15.00</b> .5906	<b>32.00</b> 1.2598	<b>9.00</b> .3543	3337	5125	15	<b>3.969</b> .1563	87000**	70000	26	79	158
HYSV7002A-2VZ C TA	<b>15.00</b> .5906	<b>32.00</b> 1.2598	<b>9.00</b> .3543	2336	5125	15	<b>3.969</b> .1563	131000**	87000	26	79	158
SV7002A-2VZ E TA	<b>15.00</b> .5906	<b>32.00</b> 1.2598	<b>9.00</b> .3543	3131	4902	15	<b>3.969</b> .1563	74000**	59000	26	79	158
HYSV7002A-2VZ E TA	<b>15.00</b> .5906	<b>32.00</b> 1.2598	<b>9.00</b> .3543	2192	4902	15	<b>3.969</b> .1563	111000**	74000	26	79	158
SV7903A-2VZ C TA	<b>17.00</b> .6693	<b>30.00</b> 1.1811	<b>7.00</b> .2756	2402	3554	16	<b>3.175</b> .1250	88000**	70000	18	55	110
HYSV7903A-2VZ C TA	<b>17.00</b> .6693	<b>30.00</b> 1.1811	<b>7.00</b> .2756	1682	3554	16	<b>3.175</b> .1250	132000**	88000	18	55	110
SV7903A-2VZ E TA	<b>17.00</b> .6693	<b>30.00</b> 1.1811	<b>7.00</b> .2756	2254	3399	16	<b>3.175</b> .1250	75000**	60000	18	55	110
HYSV7903A-2VZ E TA	<b>17.00</b> .6693	<b>30.00</b> 1.1811	<b>7.00</b> .2756	1578	3399	16	<b>3.175</b> .1250	112000**	75000	18	55	110
SV7003-2VZ C TA	<b>17.00</b> .6693	<b>35.00</b> 1.3780	<b>10.00</b> .3937	4415	6654	14	<b>4.763</b> .1875	65000**	54000	34	102	205
HYSV7003-2VZ C TA	<b>17.00</b> .6693	<b>35.00</b> 1.3780	<b>10.00</b> .3937	3091	6654	14	<b>4.763</b> .1875	96000**	69000	34	102	205
SV7003-2VZ E TA	<b>17.00</b> .6693	<b>35.00</b> 1.3780	<b>10.00</b> .3937	4143	6363	14	<b>4.763</b> .1875	56000**	46000	34	102	205
HYSV7003-2VZ E TA	<b>17.00</b> .6693	<b>35.00</b> 1.3780	<b>10.00</b> .3937	2900	6363	14	<b>4.763</b> .1875	82000**	59000	34	102	205
SV7904A-2VZ C TA	<b>20.00</b> .7874	<b>37.00</b> 1.4567	<b>9.00</b> .3543	3868	5394	16	<b>3.969</b> .1563	70000	56000	27	81	162
HYSV7904A-2VZ C TA	<b>20.00</b> .7874	<b>37.00</b> 1.4567	<b>9.00</b> .3543	2708	5394	16	<b>3.969</b> .1563	105000	70000	27	81	162
SV7005A-2VZ C TA	<b>25.00</b> .9843	<b>47.00</b> 1.8504	<b>12.00</b> .4724	7909	10661	17	<b>5.556</b> .2187	56000	44000	53	160	320
HYSV7005A-2VZ C TA	<b>25.00</b> .9843	<b>47.00</b> 1.8504	<b>12.00</b> .4724	5536	10661	17	<b>5.556</b> .2187	83000	56000	53	160	320

\* The indicated speed limits are guidelines for spring-loaded single bearings with low loads; depending on the respective application, higher or lower speed limits may apply in application.

\*\* For use with oil lubrication, these bearings are also available without shields. Almost all bearing types can also be enhanced with GRW XTRA. Detailed information you can find on page 79 and following.

• Subject to change. Additional types on request!

## Profiled rollers

Profiled rollers are double-row ball bearings; which means they are able to accept axial loads in both directions, as well as high radial loads. Usually, the contact surface is shaped like a Gothic arch; the contact surface and shaft touch each other in two locations.

On request, other contour surface designs are available (e.g. V groove, spherical outer ring, etc.).

Inner and outer rings can be made of chrome steel 100Cr6 or corrosion-resistant chrome steels X65Cr13 or X30CrMoN 15-1. Balls can be made of chrome steel 100Cr6, X65Cr13 or ceramic.

GRW profiled rollers have non-contact shields. On request, contact seals (e.g. Teflon<sup>®</sup>, NBR) are available as an alternative. The rollers are lubricated for life and are also available with FDA-approved and/or auto-clavable lubricants.

For further information please contact your nearest GRW Sales Representative.

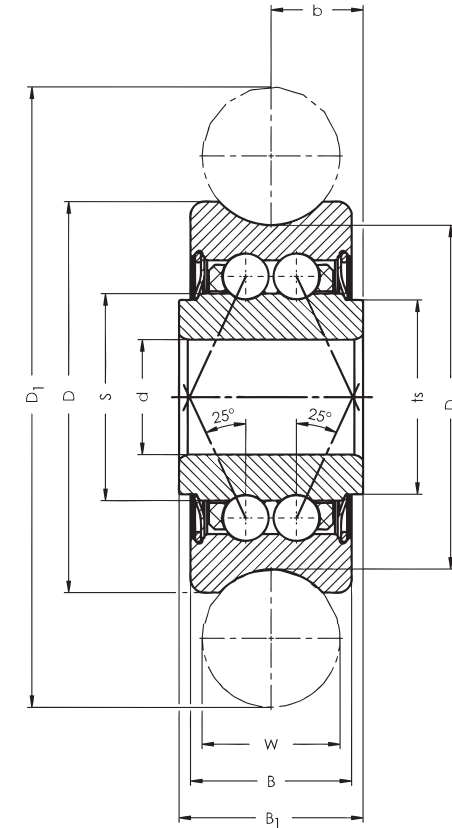

Profile roller with inner ring extended on both sides

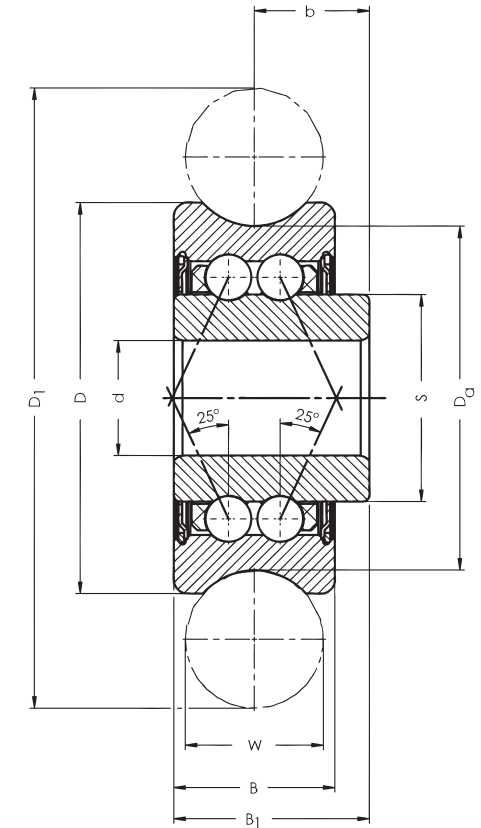

Profile roller with inner ring extended on one side

Basic symbol	Drawing no.	d	D <sub>a</sub>	D	D <sub>1</sub>	W	B	B <sub>1</sub>	b	S
687/603282-2RZ	604623	5	-	17	27	6	7	8	4	9
687/603282-2Z	603282	5	-	17	27	6	7	8	4	9
687/602057-2Z	602057	5	-	17	25	5	7	8.5	5	9
687/601938-2Z	601938	5	-	17	27	6	7	8.5	5	9
687/601935-2Z	602055	5	-	16	22	4	7	8.5	5	9
687/601935-2Z	601935	5	-	16	22	4	7	8.5	5	9
608/602030-2ZF	604976	8	-	24	34	6	11	11	5.5	11.8
608/602030-2ZF	602030	8	-	24	34	6	11	11	5.5	11.8
608/602024-2ZF	602024	8	-	24	37	8	11	12.5	7	11.8
608/601947-2ZF	602053	8	-	24	34	6	11	12.5	7	11.8
608/601947-2ZF	601947	8	-	24	34	6	11	12.5	7	11.8
6201/604947-2Z	604947	12	-	35	51.3	10	15.9	15.9	7.95	18.28

Subject to change.

## Bearing units

Bearing units are pre-mounted assemblies, comprising of at least one ball bearing, shaft or housing, optional spacers, shims or spring washers.

GRW assembles the stacked components in bearing units primarily by using adhesives. Backlash free bearing units are produced cost effectively by precisely gluing the bearings under an axial pre-load. GRW has engineered special gluing equipment and techniques to ensure high accuracy and strength.

When using GRW bearing units, customers will profit from the following benefits:

- Cost advantages by eliminating possibility of improper customer assembly.
- Pre-mounted units are easier to handle than single bearings.
- At GRW the bearings are mounted in a clean room under optimum conditions.

- Depending on the application requirements, other functional elements may be integrated in the bearing units, for example springs and seals.

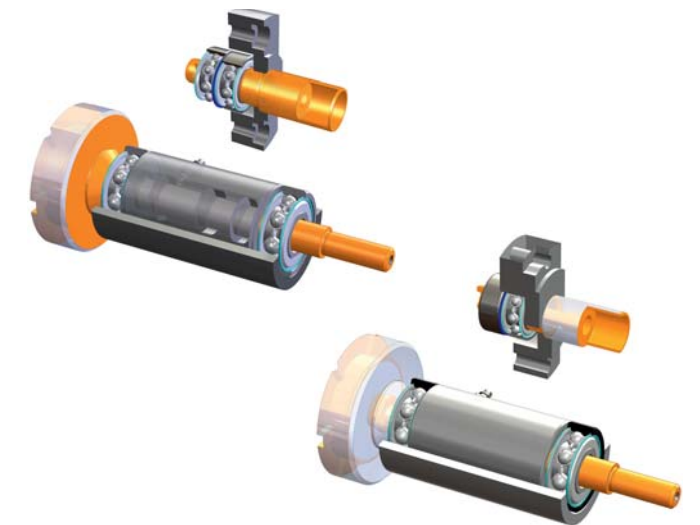

## Thin-section bearings

Thin-section bearings are bearings with very thin ring cross-sections (light ISO dimension series 67/68) or bearings with identical cross-sections, independent of their bore diameter (inch series: Extra Thin Series, Thin Series).

In addition to their small footprint and low weight, they are characterized by low torque and high rigidity.

Thin-section bearings are available in the following versions: open (standard), with closures, with an extended inner ring, with a flanged outer ring and as an angular contact or full-complement bearing at a maximum outside diameter of 40 mm.

The closures are available in -2Z and -2TS versions.

By default, thin-section bearings are all ABEC5. Please inquire about other available versions (e.g. Superduplex) ABEC7, and ABEC9.



Basic symbol	d		D		B		r <sub>s min</sub>		d <sub>a min</sub>		d <sub>a max</sub>		D <sub>a max</sub>	
	[mm]	[inch]	[mm]	[inch]	[mm]	[inch]	[mm]	[inch]	[mm]	[inch]	[mm]	[inch]	[mm]	[inch]
15875A	15.875	.625	22.225	.875	3.967	.156	0.25	.010	16.9	.665	17.9	.705	20.6	.811
15875A-2Z	15.875	.625	22.225	.875	4.978	.196	0.25	.010	16.9	.665	17.9	.705	20.6	.811
15875A-2TS	15.875	.625	22.225	.875	4.978	.196	0.25	.010	16.9	.665	17.2	.677	20.6	.811
19050A	19.050	.750	25.400	1.000	3.967	.156	0.25	.010	20.1	.791	21.1	.831	23.7	.933
19050A-2Z	19.050	.750	25.400	1.000	4.978	.196	0.25	.010	20.1	.791	21.1	.831	23.7	.933
19050A-2Z	19.050	.750	25.400	1.000	4.978	.196	0.25	.010	20.1	.791	20.4	.803	23.7	.933
22225A	22.225	.875	28.575	1.125	3.967	.156	0.25	.010	23.3	.917	24.3	.957	26.9	1.059
22225A-2Z	22.225	.875	28.575	1.125	4.978	.196	0.25	.010	23.3	.917	24.3	.957	26.9	1.059
22225A-2TS	22.225	.875	28.575	1.125	4.978	.196	0.25	.010	23.3	.917	23.6	.929	26.9	1.059
26988A	26.988	1.063	33.338	1.313	3.967	.156	0.25	.010	28.1	1.106	29.1	1.146	31.7	1.248
26988A-2Z	26.988	1.063	33.338	1.313	4.978	.196	0.25	.010	28.1	1.106	29.1	1.146	31.7	1.248
26988-2TS	26.988	1.063	33.338	1.313	4.978	.196	0.25	.010	28.1	1.106	28.4	1.118	31.7	1.248
31750A	31.750	1.250	38.100	1.500	3.967	.156	0.25	.010	32.8	1.291	33.8	1.331	36.4	1.433
31750A-2Z	31.750	1.250	38.100	1.500	4.978	.196	0.25	.010	32.8	1.291	33.8	1.331	36.4	1.433
31750A-2TS	31.750	1.250	38.100	1.500	4.978	.196	0.25	.010	32.8	1.291	33.1	1.303	36.4	1.433
34925A	34.925	1.375	41.275	1.625	3.967	.156	0.25	.010	36.0	1.417	37.0	1.457	39.5	1.555
34925A-2Z	34.925	1.375	41.275	1.625	4.978	.196	0.25	.010	36.0	1.417	37.0	1.457	39.5	1.555
34925A-2TS	34.925	1.375	41.275	1.625	4.978	.196	0.25	.010	36.0	1.417	36.3	1.429	39.5	1.555

Subject to change.

## Hybrid and full ceramic ball bearings

Conventional ball bearings are limited when operating at high temperatures, in a vacuum, or in a corrosive environment. All ceramic bearings have proven to be ideally suited for these extreme applications.

Zirconium oxide (ZrO<sub>2</sub>) and silicon nitride (Si<sub>3</sub>N<sub>4</sub>) are typical materials used in all ceramic bearings. Both provide excellent corrosion and temperature resistance as well as other mechanical properties.

### Material properties:

Properties	Unit	Si <sub>3</sub> N <sub>4</sub> HY	ZrO <sub>2</sub> ZO
Density	g/cm <sup>3</sup>	3.2	6.05
Hardness	Rc	> 75	> 69
E-module	GPa	320	200
Poisson coefficient		0.26	0.2
Linear expansion coefficient	x10 <sup>-6</sup> K <sup>-1</sup>	2.9	10
Max. temperature	°C	800	600
Corrosion resistance		very good	good
Electrical conductivity		insulator	insulator

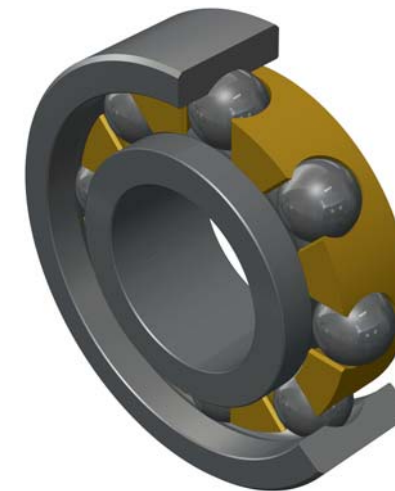

### High chemical resistance

All ceramic ball bearings have specific advantages for applications with mixed-torque because they remain operative for a longer period of time than conventional steel bearings even in the case of lube deprivation.

### Corrosion resistance

All ceramic bearings resist cold micro welding to other materials which allows for particularly low adhesive wear. Certain applications make use of conventional bearings almost impossible. For example: corrosive material resistance of all ceramic bearings allows for usage in chemical applications.

### Thermal expansion

Full ceramic bearings will remain dimensionally stable even at high temperature fluctuations.

### Non-magnetic and current insulation

The non-magnetic properties of ceramic materials prevent interference with magnetic fields and furthermore acts as an insulator preventing current flow.



## Special ball bearings

GRW develops and produces a complete range of custom bearing options.

### Superduplex bearings

Superduplex bearings are also known as double row deep groove ball bearings or angular contact ball bearings featuring split inner or outer rings. One of the ring sets, either outer or inner, consist of a double row integral set of raceways.

This compact design permits easy handling and assembly. The inner or outer split rings are paired according to customer specifications ensuring that GRW bearings will meet the required axial preload.

### Extraduplex bearings

Extraduplex bearings are double-row deep groove radial bearings or angular contact ball bearings with a split inner or outer ring. One floating ring is accurately preloaded and then laser-welded in place. This style of bearing prevents radial offset or changes in axial preload during assembly.

### Tandemduplex bearings

Tandemduplex bearings are designed with double-row deep groove bearings. The raceways are extremely close to each other (in the micron range). These bearings are designed to handle both radial loads and axial loads in one direction by ensuring that the load is evenly distributed to all balls.

### Bearings with custom outer geometries

GRW can produce single or double-row bearings with a spherical faced or grooved outer ring and also can provide molded and plastic rubber type assemblies.

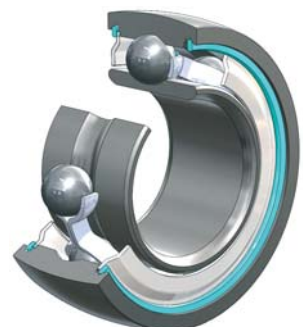
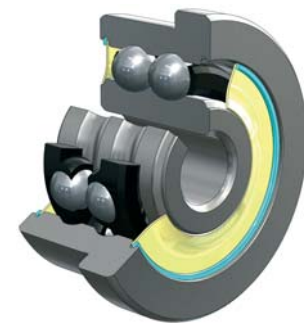
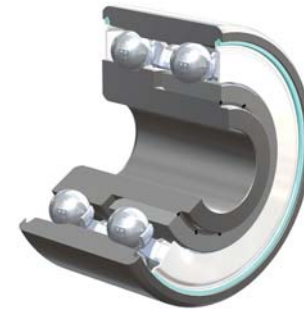

### Integrated shaft bearings

Bearing and shaft can be combined to provide an integrated assembly. In this design the raceway is ground on the shaft and the bearing assembly is delivered completely assembled ready to use.



### Bearing / housing assemblies

For these special designs, the raceway of the outer ring is ground directly into the housing. Complex housings, flanges and threaded mounting holes maintain the tight tolerances necessary for proper installation.



### Precision components

GRW manufactures precision spacers and precision components that incorporate threads, steps, grooves, bores, etc. to tolerances in the micron ( $\mu$ ) range.

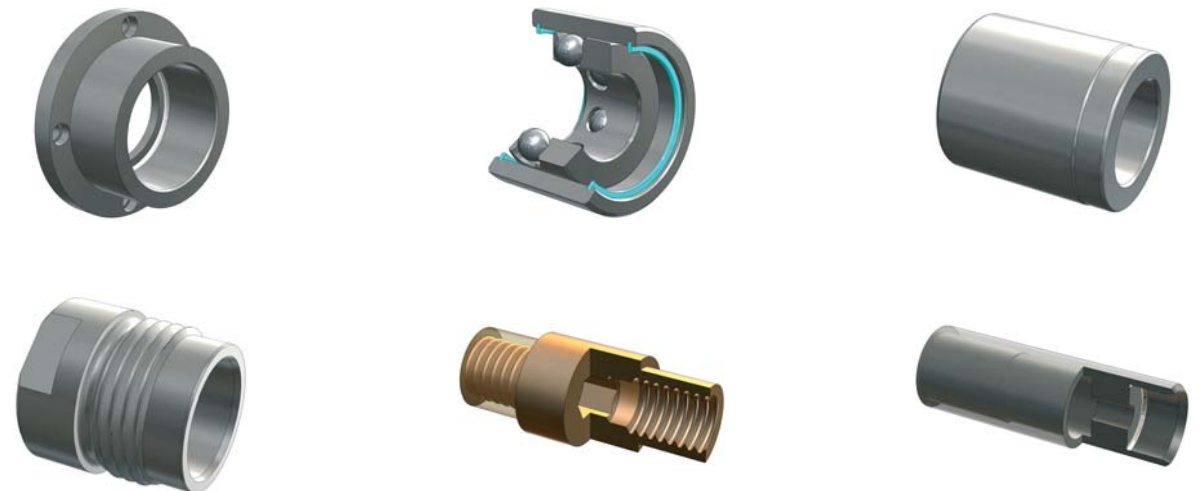

## Coated bearings

Sometimes the use of conventional lubricants is impossible especially in applications where there is exposure to extremely high or low temperatures, ultra-high vacuum, or in close proximity to optical systems.

The solution in these cases may be special coatings with gold, silver, MoS<sub>2</sub>, or Teflon®. These thin layers act as a **dry film lubricant**. Development of this technology has made applications possible even at temperatures of -270 °C to +400 °C or in a high vacuum.

Protection against wear is also an advantage of using thin coated bearings. Raceways, balls, or outer surfaces can be thinly coated to meet each application's requirements. Possible uses for these types of coatings are profiled rollers, paper cutting blade wheels, bearings used in chemical or food processing industry, medical instruments, aerospace and vacuum technology.

As each coating can be applied by a variety of technologies, GRW will work with each customer to select the optimum coating process to meet your application requirements.

Special developed for applications in extreme conditions we offer our customers special ball bearing solutions with the new coating system **XTRAc Coat**. Further information you can find on the following pages.



# XTRA

## ENHANCING PERFORMANCE!

**XTRAc Coat** / The new GRW coating system

**XTRAlube** / Lubrication for longer life

**XTRAlon** / The Premium retainer material

## XTRA Enhancing Performance!

In order to successfully meet the challenges of the market, our products are being continuously developed and their performance improved, based on the latest innovations from GRW.

Developments that we have achieved in the areas of product design, ball bearing steels, retainer design and materials, lubricants and surface coatings are the basis for the technological leadership the company has today.

With GRW **XTRA**, we are not so much reinventing the ball bearing but using our expertise to improve performance levels in terms of running noise, service lifetime and speed for instance. The ball bearing designed by GRW to your individual requirements acquires superior performance due to **XTRA**.

### XTRA – the GRW solution for your challenges!

For more information about **XTRA** contact our sales engineers. They will be glad to advise you.

☎ worldwide: **+49 (0) 93 65/819 - 440**  
 ☎ USA: **+1 (804) 328 0900**  
 ✉ **xtra@grw.de**

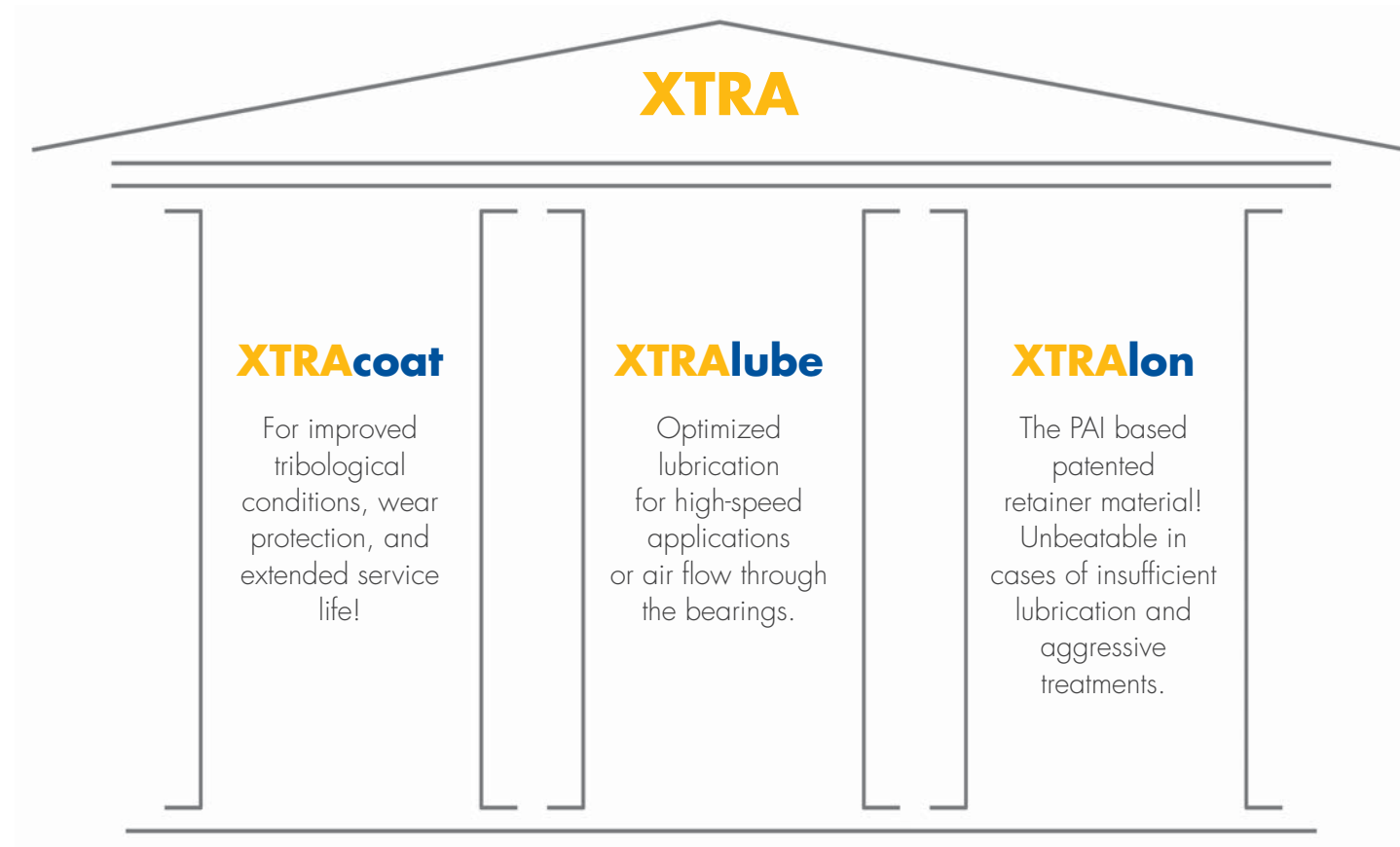

## XTRAc Coat

Originally developed for extreme conditions in handpieces of medical and dental equipment and however excellently suitable for any other application, we offer our customers special ball bearings with the new coating system **XTRAc Coat**.

The coating developed exclusively for GRW equips the ball bearing components with the special capability to bind the applied grease to surfaces, and therefore to prevent as far as possible an insufficient lubrication situation from occurring, even under adverse operating conditions.

Which leads to a significantly higher service life, even in extreme cases where hygienic cleaning is done and maintenance is omitted.

Validating the effect of **XTRAc Coat** at a contact angle measurement with dental maintenance oil, can be clearly seen that the contact angle falls below 5° using **XTRAc Coat**.

### untreated surface



Contact angle: 24,2° (material: X65Cr13; 1.4037)

### treated surface



Contact angle: 4,9° (material: X65Cr13; 1.4037)

### Facts about GRW XTRAc Coat:

- It is possible to completely wet ring or ball surfaces with minimum oil quantities.
- Less oil escapes from the ball bearing to the environment.
- The oil adheres better to the surfaces, consequently starved lubrication is avoided or delayed.
- Bearing life is prolonged.

## XTRAlube



For the toughest operating conditions in special applications, GRW relies on developing its own lubricants, which have the potential for significantly longer life: **XTRAlube**.

The new **XTRAlube** developed in the GRW laboratory delivers outstanding results both in the test criteria which GRW considers crucial and in the various functional tests. It also has the special ability to adhere to the contact surfaces of the inner ring and outer ring much better than standard greases.

In the specific case of ball bearings for dental turbines this property is particularly sought after, because the air extracted from the turbine flows partly through the ball bearings and transports the grease reservoir to the outside very rapidly. This leads to a situation of inadequate lubrication, which is responsible for the failure of the ball bearings.

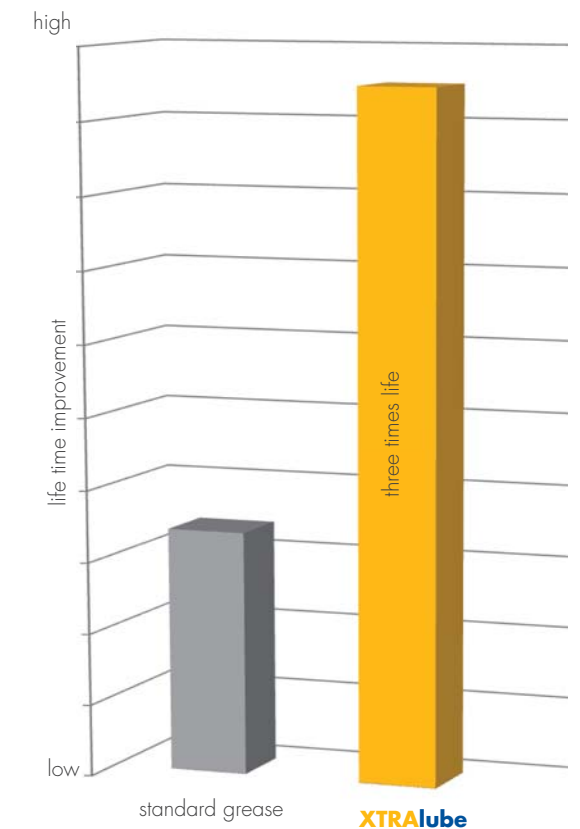

Average value at life test on the GRW test bench Orakel III. Initially lubricated and no relube during test.

## XTRAlon

Our premium material is designed for the most demanding requirements in terms of friction, thermal stability and wear. The unique production method involving the chemical binding of solid lubricant to the base polymer polyamidimide (PAI) creates a homogeneous, dense fabric, which offers little opportunity for attack by the superheated steam during autoclaving.

The fine distribution of solid lubricant and the chemical bond to the base material means that the exceptional property of dry-running suitability is obtained, even in extreme applications where idle speed of  $n \times dm > 1.000.000 \text{ mm/min}$  are the norm. In internal tests on GRW's own test rigs, service lifetimes of up to 15 hours were attained with completely dry ball bearings. All conventional retainer materials fail after only a few minutes in the same test.

The SEM images show the surfaces of XTRAlon and PAI mod. after 1.000 cycles of sterilization by steam under pressure. It can be clearly seen that the surface structure of XTRAlon is preserved, while the PAI mod. has a very jagged surface.

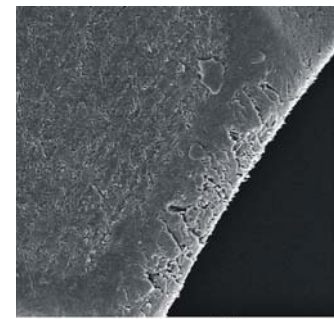

SEM image: PAI mod.

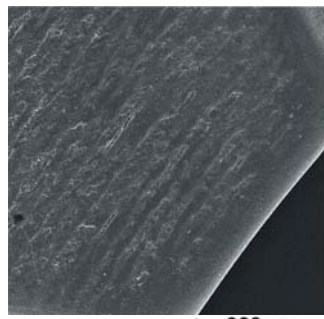

SEM image: XTRAlon

### Life time test with XTRAlon modified ball bearings without initial lubrication:

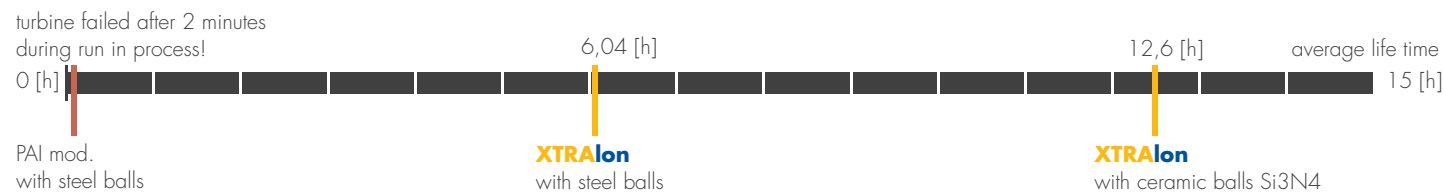

Effect of the retainer material to the life time of dental turbines without any initial lubrication tested on Orakel III test bench ( $n=350.000 \text{ min}^{-1}$ ).

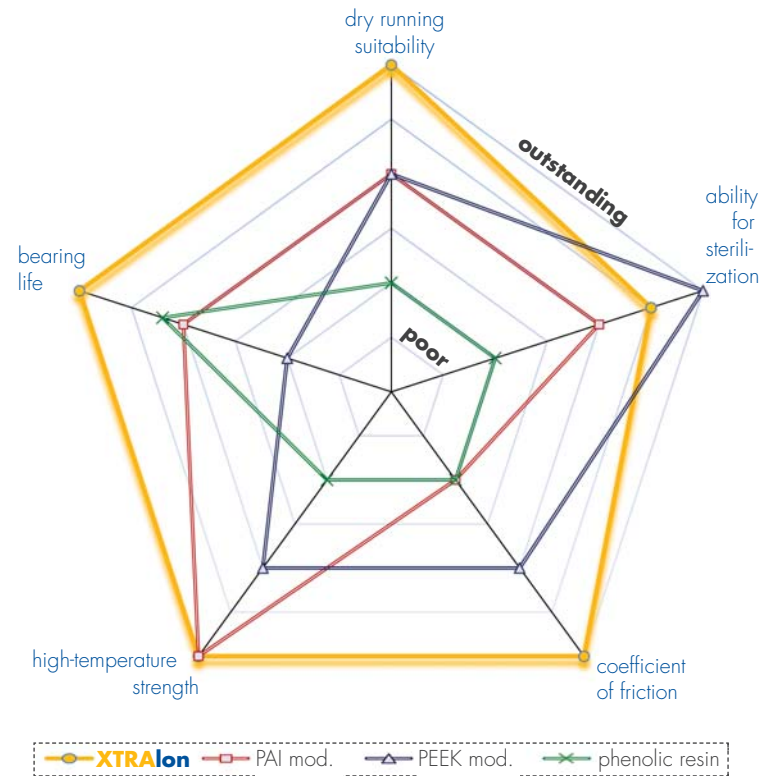

Performance overview of standard retainer materials compared to GRW XTRAlon used in high-speed dental handpieces.



## Your success with GRW XTRA bearings:

As part of a development project for a major GRW customer, extremely high performance improvements over the current product design were obtained, in conjunction with XTRA developments. As part of this, parameters such as running noise, product service life and idle speed were tested on GRW internal test rigs and optimized by applying XTRA advancements.

### GRW customers benefit from our XTRA bearings:

- Silent bearings ensure a more pleasant work in the dental field and any other application
- The high product reliability of GRW XTRA bearings ensures longer life time and reduces costs.
- Higher idle speed.
- GRW XTRA makes ball bearings resistant and more durable despite poor care, extreme temperatures and highest speeds.

Our benchmarks and results using XTRA products:

Measurable target	2013	2014 XTRA	Improvement
Noise [dB(A)]	70	65	- 29% *
Life time [h]	90	260	+ 189%
Early failure [h]	> 50	> 120	+ 140%
Idle speed [rpm]	360.000	370.000	+ 3%

Improvement of a high speed handpiece of a GRW customer.  
\* Decrease by 10 dB is a reduction of the noise level by 50% (logarithmic scale).

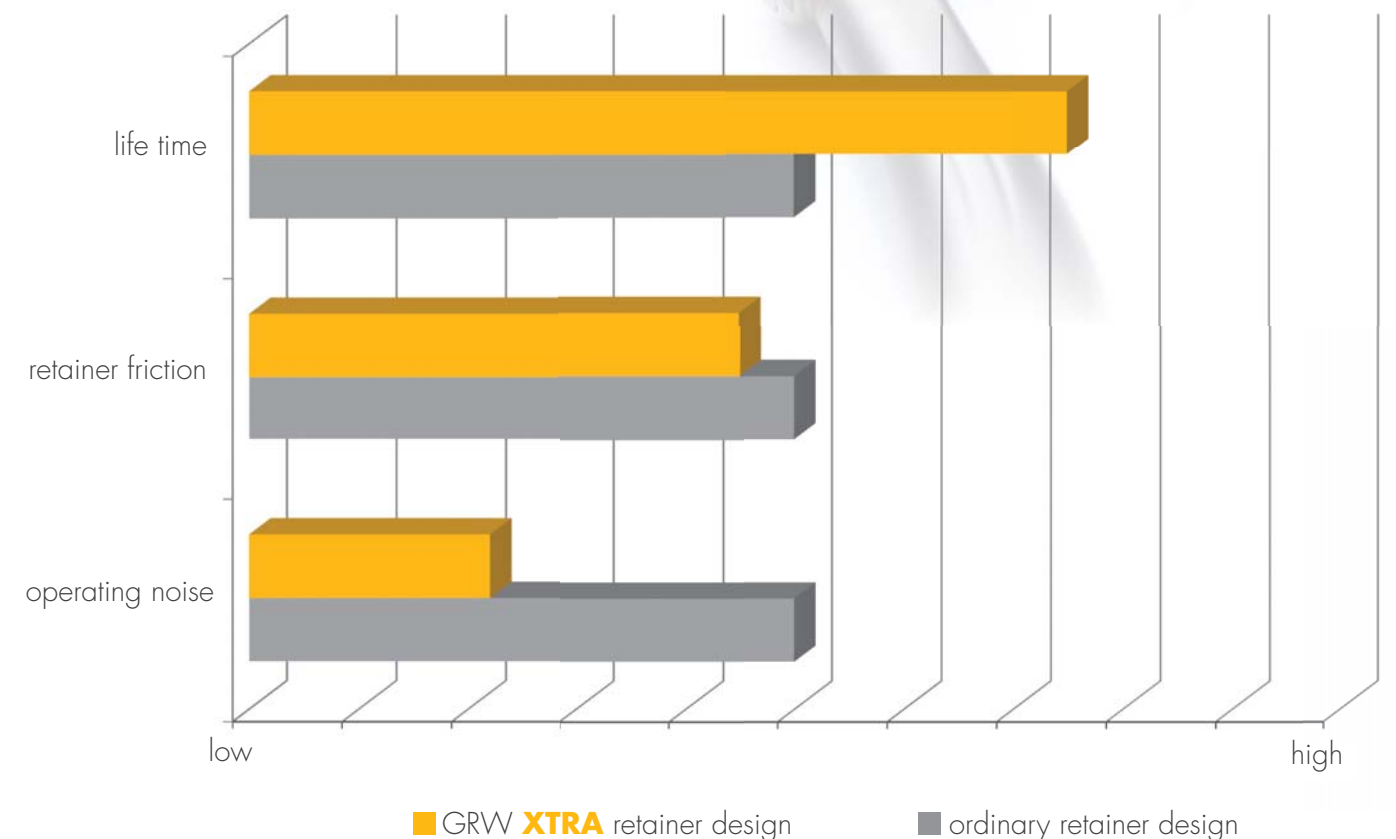

Effect of retainer design on the running properties of high-speed dental ball bearings.

## Accessories

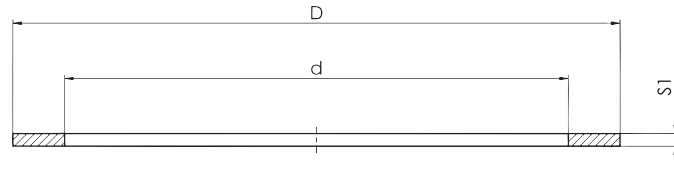

### Shims AS

For production engineering purposes, shims are often used to balance the accumulation of tolerances (tolerance chains) and axial tolerances.

GRW spring washers are made of corrosion-proof 1.4310 (AISI 301) spring wire. They are heat-treated, burr-free, and have an extremely fine surface finish

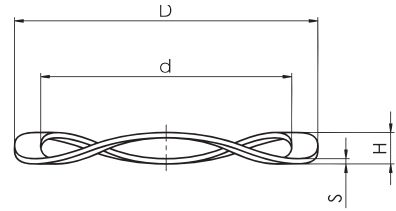

### Spring washers WF

Spring washers are used for defined axial preloading of bearings, particularly for miniature and small ball bearings. The manufacture of these spring washers includes cutting and punching processes. Through a subsequent finishing process, they can be calibrated to provide highly accurate preload tolerances for special applications.

GRW spring washers are made of corrosion-proof 1.4310 (AISI 301) spring wire. They are heat-treated, burr-free, and have an extremely fine surface finish. Our spring washers are designed with 3 waves ensuring even support of the bearing during axial preloading.

Shims d x D	Dimensions [mm]			Compatible sizes	
	s	Spring washers (d x D x H x s)	Spring constant [N/mm]	on shafts	in housings
AS 1.55 x 2.50	0.15	–	–	68/1,5, 69/1,5	–
–	–	WF 1.60 x 2.90 x 0.40 x 0.06	50.0	–	–
–	–	WF 1.90 x 2.80 x 0.50 x 0.08	60.0	–	–
AS 2.00 x 4.30	0.10 0.16 0.20	–	–	–	–
AS 2.25 x 3.20	0.08 0.10	WF 2.15 x 3.10 x 0.50 x 0.08	54.9	682, 692, 5/64	–
AS 2.80 x 3.90	0.08 0.10	WF 2.70 x 3.80 x 0.50 x 0.08	52.0	60/2,5, 68/2,5, 69/2,5, 3/32	68/1,5, 691, 1191
AS 3.05 x 4.50	0.10 0.16 0.20	–	–	–	–
AS 3.30 x 4.40	0.08 0.10 0.12	WF 3.20 x 4.30 x 0.50 x 0.10	32.5	623, 683, 693, 1/8A, 1/8B, 3175, 1/8A/6, 1/8B/083	–
AS 3.50 x 5.00	0.08	–	–	–	–
AS 3.80 x 4.90	0.08 0.10 0.12	WF 3.70 x 4.80 x 0.55 x 0.10	32.0	–	682, 69/1,5
AS 4.05 x 5.50	0.10 0.20	–	–	–	–
AS 4.30 x 5.85	0.10 0.12 0.15	WF 4.20 x 5.75 x 0.65 x 0.12	40.0	604, 624, 634, 684, 694, 3967	68/2,5, 692
AS 4.90 x 6.20	0.10 0.12 0.15	WF 4.80 x 6.10 x 0.60 x 0.12	37.0	3/16, 4763A, 4763B	5/64, 3175
AS 5.20 x 6.75	0.15	–	–	–	–
AS 5.30 x 6.85	0.10 0.12 0.15	WF 5.20 x 6.75 x 0.65 x 0.12	22.0	625, 635, 685, 695	683, 69/2,5
AS 5.50 x 8.50	0.40	–	–	–	–
AS 6.30 x 7.85	0.12 0.15 0.18	WF 6.20 x 7.75 x 0.70 x 0.15	38.0	626, 686, 696	60/2,5, 693, 3/32, 1/8A, 3967, 4763A
AS 6.70 x 9.40	0.10	–	–	–	–
AS 7.30 x 8.80	0.12 0.15 0.18	WF 7.20 x 8.70 x 0.90 x 0.15	28.5	607, 627, 687, 697	684
–	–	WF 7.20 x 12.00 x 1.55 x 0.13	41.8	607, 627	6350B, 7938, 1/8B/083
AS 8.30 x 9.80	0.10 0.15 0.18 0.20	WF 8.20 x 9.70 x 0.85 x 0.18	26.0	608, 688, 698, 7938	623
AS 9.30 x 10.80	0.15 0.18 0.20	WF 9.20 x 10.70 x 1.15 x 0.18	22.0	609, 629, 689, 699	685, 694
AS 10.30 x 11.80	0.18 0.20 0.22	WF 10.20 x 11.70 x 1.05 x 0.20	18.5	6000, 6800, 6900, 3/8	604
–	–	WF 10.50 x 15.80 x 1.85 x 0.25	77.0	6000	625, 634
AS 11.30 x 12.80	0.18 0.20 0.22	WF 11.20 x 12.70 x 1.30 x 0.20	16.0	–	624, 686, 695
AS 12.30 x 13.80	0.20 0.22 0.25	WF 12.20 x 13.70 x 1.30 x 0.22	20.0	–	687
AS 13.30 x 14.80	0.20 0.22 0.25	WF 13.20 x 14.70 x 1.30 x 0.22	13.0	–	696
AS 14.35 x 15.80	0.22 0.25 0.30	WF 14.20 x 15.65 x 1.55 x 0.25	17.0	–	625, 634, 688, 1/4A
AS 15.35 x 16.80	0.22 0.25 0.30	WF 15.20 x 16.65 x 1.55 x 0.25	14.5	–	689, 697
AS 16.00 x 22.00	0.10	WF 15.80 x 21.80 x 1.60 x 0.20	10.0	–	3/8
AS 16.40 x 18.80	0.25 0.30 0.35	WF 16.20 x 18.55 x 2.15 x 0.30	28.5	–	607, 626, 635, 6800, 698, 1/4

Material 1.4310 (AISI 301). Before planning to use shims and spring washers, please check on availability. Other sizes on request. Subject to change. Minimum quantity 100 pieces.

## Accessories

### Retaining rings – (shaft circlips WSR, bore retaining rings BSR)

Retaining rings are precision engineered components designed to be applied on shafts or in bores providing a shoulder that accurately positions, locates and retains parts of an assembly. They are especially useful with small and evenly distributed axial and radial loads. It is important to ensure that the face of the retaining ring does not touch the edge radius of the bearing. If the face does touch the radial edge, we recommend that you use our shims in conjunction with our retaining rings.

GRW retaining rings are constructed from cold-drawn spring wire 1.4310 (AISI 301), which exhibits a constant cross section. They are corrosion-proof and free of any scale or burrs.

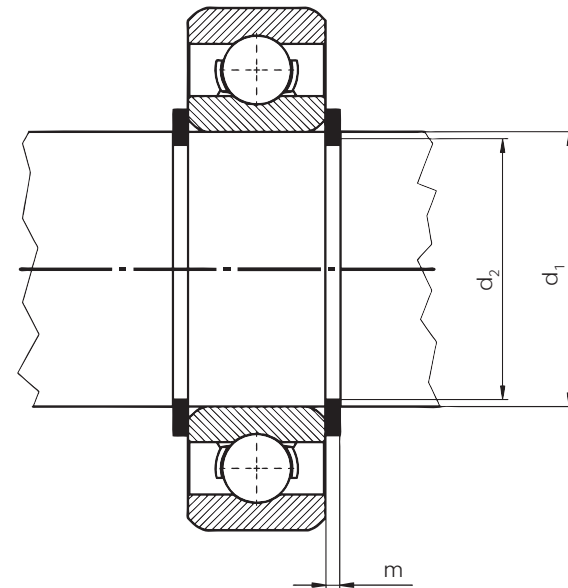

Assembly using shaft circlips

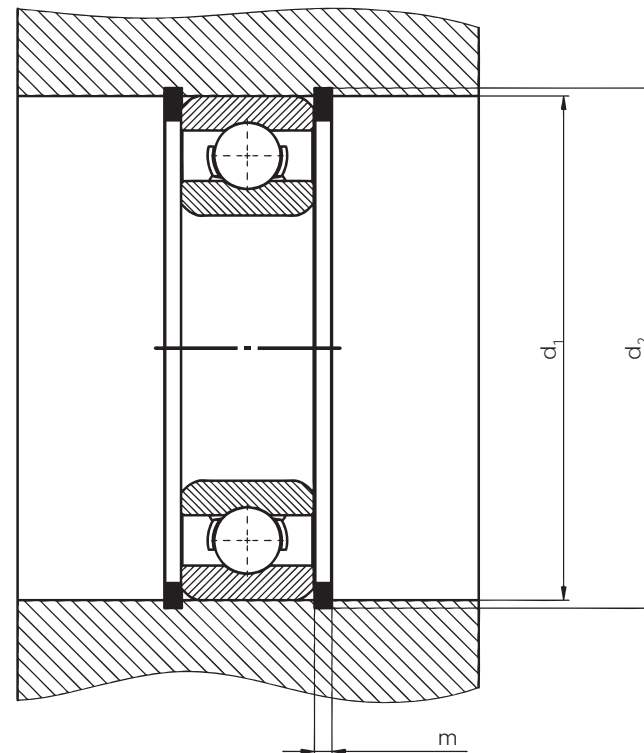

Assembly using bore circlips

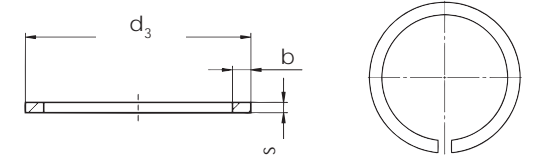

### Shaft circlips

Type	Shaft $d_1$	Dimensions [mm]				Gro	
		$d_3$ max.	Split lock $b$ $\pm 0.10$	$s$ $\pm 0.02$	$d_2$ $-0.05$	$m$ $+0.03$	
WSR 3	3	2.60	0.50	0.30	2.70	0.33	
WSR 4	4	3.60	0.50	0.30	3.70	0.33	
WSR 5	5	4.50	0.70	0.40	4.60	0.44	
WSR 6	6	5.45	0.70	0.40	5.60	0.44	
WSR 7	7	6.45	0.70	0.40	6.60	0.44	
WSR 8	8	7.35	0.90	0.50	7.50	0.55	
WSR 9	9	8.30	0.90	0.50	8.50	0.55	
WSR 10	10	9.25	0.90	0.50	9.50	0.55	

Material 1.4310 (AISI 301). Subject to change. 1000 pieces per pack.

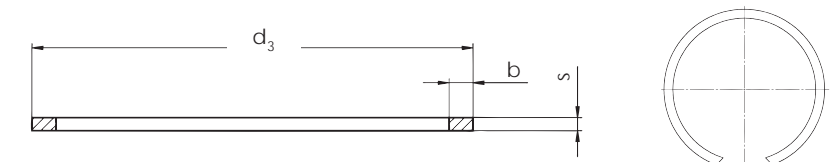

### Bore circlips

Type	Shaft $d_1$	Dimensions [mm]				Gro	
		$d_3$ min.	Split lock $b$ $\pm 0.10$	$s$ $\pm 0.02$	$d_2$ $-0.05$	$m$ $+0.03$	
BSR 4	4	4.40	0.50	0.30	4.30	0.33	
BSR 5	5	5.45	0.50	0.30	5.30	0.33	
BSR 6	6	6.45	0.50	0.30	6.30	0.33	
BSR 7	7	7.50	0.50	0.30	7.30	0.33	
BSR 8	8	8.60	0.70	0.40	8.40	0.44	
BSR 9	9	9.60	0.70	0.40	9.40	0.44	
BSR 10	10	10.65	0.70	0.40	10.40	0.44	
BSR 11	11	11.65	0.70	0.40	11.40	0.44	
BSR 12	12	12.75	0.90	0.50	12.50	0.55	
BSR 13	13	13.75	0.90	0.50	13.50	0.55	
BSR 14	14	14.80	0.90	0.50	14.50	0.55	
BSR 15	15	15.80	0.90	0.50	15.50	0.55	
BSR 16	16	16.85	0.90	0.50	16.50	0.55	
BSR 17	17	17.85	0.90	0.50	17.50	0.55	
BSR 19	19	20.00	1.10	0.60	19.60	0.66	

Material 1.4310 (AISI 301). Subject to change. 1000 pieces per pack.

## Test engineering

### Orakel III

The test module developed by GRW can be freely lined to form test series. Automated and with a minimum of personnel expenditure, it tests the lifetime of high-speed dental handpieces, allowing for fast and efficient comparison of a development stage with the previously determined reference.

For evaluation of the performance characteristics of the entire system, the test process in respect of the mechanical load cycle and test criteria can be parameterized and is thus objectively reproducible. Calibration, test parameter settings and documentation of results are carried out on a commercially available PC. The actual test is carried out self-sufficiently.

#### Benefits:

- Up to 7,000 cycles can be executed without interruption.
- Uniform test process can be exactly reproduced.
- The operation of the modules only requires power and clean compressed air.
- Testing capacities can be expanded at any time by adding additional modules.
- Easy documentation: For each cycle, the measured speed is stored and can be written in a text file along with details of the completed testing time.
- Up to 10 modules can be controlled by one PC.



**Note:** Orakel III, the test module developed by GRW, is available for purchase. Contact us for more details.

### Speedmaster

The GRW Speedmaster is a noncontact speed-measuring device especially designed for high RPM rotating instruments used in the dental industry.

It may also be used for other high-speed applications such as motors or high-frequency spindles.



**Note:** Speedmaster, the test module developed by GRW, is available for purchase. Contact us for more information.

The set includes: the basic measuring unit, AC adapter, speed sensor, permanent magnet, a hard metal test probe for clamping in the dental instrument, and a measuring stand to hold the speed sensor.

#### Measurement Principle

A test probe or a motor shaft is magnetized by means of the attached permanent magnet. The sensor is positioned 1 to 10 mm away from the magnetized shaft. When the shaft rotates, the weak magnetic field is recorded by the special GRW sensor, then amplified and displayed in RPM, or revolutions per minute.

The non-contact measurement is designed for speeds from 20,000 to 600,000 min<sup>-1</sup>.

This device has proven to be particularly useful in development and production as well as in the repair of dental turbines and surgical handpieces.

## GRW laboratory services

GRW – the specialists in high-precision miniature ball bearings now offer laboratory services as well.

Do you want to analyze materials? Do you need surface treatment but do not have your own laboratory or do you simply lack the expertise?

Then act flexibly and make use of the services of a competent analysis and chemistry laboratory!

We are the right partner, especially when it comes to such demanding procedures as FTIR spectroscopy with ATR technology or the functional and decorative gold plating of components.

#### GRW offers the following services:

General analysis, e.g. the determination of

- pH
- Acid concentration
- Oil or preservative content
- Evaporation residue
- Nitrite levels

Lubricant analysis with determination of protection by means of

- Dissolving and filtering
- Microscopy
- FTIR analysis

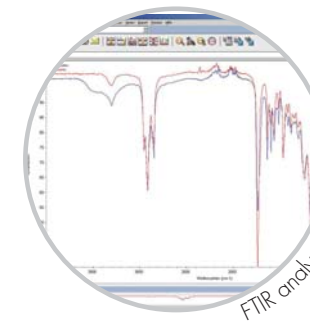

#### Surface treatments

- Gold plating
- Ultrasonic cleaning
- Hot and cold bronze finishing
- Passivating high-alloy steels

#### Medical hygiene treatments

- Steam pressure sterilization
- Thermal disinfection

#### Condensation – and salt spray test

- Corrosion testing according to DIN 50021 / ASTM B117-73



As a partner of laboratory network GRW is able to offer you additional services apart from our own spectrum:

Examinations with scanning electron microscope (SEM) and X-ray spectroscopy (EDX)

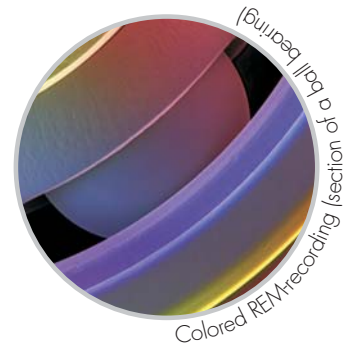

X-ray fluorescence analysis (RFA)

Detailed analysis by means of differential scanning calorimetry (DSC)

Thermal gravimetric analysis (TGA)



## Proper handling of GRW high-precision miniature bearings

GRW ball bearings are manufactured and packaged with extreme care to avoid contamination, corrosion, and other external influences on the bearings. When mounting ball bearings, please mind:

- Bearings should be stored in their original package in clean, dry rooms under constant temperature conditions.
- Bearings should only be removed from their original package shortly before they are mounted. Usage of gloves, finger cots, and tweezers are recommended.
- Assembly location has to be clean and bright. All mating parts have to be clean. A hard surface is preferred.
- When mounting a ball bearing, the assembly force must not be applied over the balls. Suitable mounting tools must be used. Non-compliance with these instructions may easily result in damage to balls or raceways, for example ball indentations may occur in the raceway.
- If glued interfaces are used, ensure that any excess glue does not enter the bearing.
- Re-lubrication should only be carried out with a lubricant of the same type and purity.

- We recommend to have the bearings lubricated by GRW as this is executed in a clean room shortly before packaging.
- Selective sorting of all mating parts will help to guarantee the proper fit of the bearing to the shaft or housing.
- We recommend a running in process for grease-lubricated bearings prior to use at low speed to achieve optimum distribution of the lubricant.
- Electrical current running through the bearing should be avoided.

### Bearing Analysis

Based on over 70 years of expertise, GRW can provide ball bearing analysis to establish the root cause of failure or to estimate the remaining life of the ball bearing. For more information about bearing analysis, please contact your nearest GRW Sales Representative.

Valuable results can be achieved when bearings are disassembled and examined after a certain period of operation before failure has occurred. Marking of the bearing rings during disassembly can help to reproduce original assembly characteristics.



Proper set up for packaging removal



Shaft assembly

### Damage due to improper handling

Defect characteristics	Possible cause											
	Contamination	Assembly	Assembly tools	Adhesive	Lubricant	Temperature	Speed	Load	Storage	Ambient media	Fitting/contact	Design
Noisy	x	x		x	x							x
Mounting problems			x								x	x
Seized bearing	x	x		x		x	x	x		x	x	
Corrosion	x								x	x	x	
Coloration						x				x		
Cracked rings								x			x	

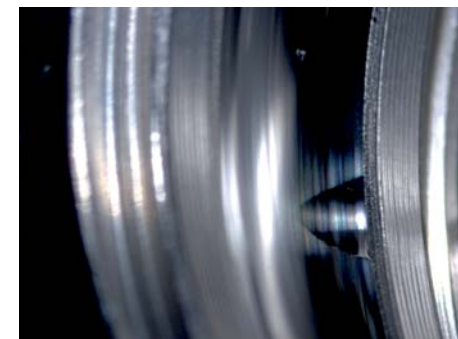

Ball indentation in raceway

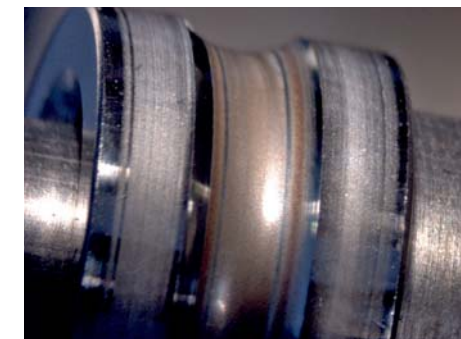

Lube deprivation



Indentations in raceway caused by particles



## Packaging

Correct packaging protects bearings from contamination, corrosion and damage during transport and storage. We recommend the package to open just prior to mounting and to use bearings with opened packages as soon as possible.

Each bearing package is labeled with the exact design specification and the respective product lot number, factory batch number, and the packaging date of the bearing.

### Our Standard packaging options are as follows:

#### Strip Packaging "CP"

Our standard packaging contains ball bearings in one strip or pill pack, sealed individually in transparent synthetic film packets with a white backing. The quantity per strip depends upon the outside diameter of the bearing.



#### Vacuum Packaging "LL"

Bearings are bulk packaged in a transparent synthetic film pack and sealed under vacuum. The quantity per vacuum pack depends on the size of the bearing or as specified by the customer.



#### Spindle bearing Packaging "CP1P"

Spindle bearings are packed in a separate envelope marked 'GRW' (CP1) and boxed individually (CP1P) to avoid damage.



#### Special Packaging

GRW offers a wide range of packaging options based upon our customer's requests and the requirement profile of the bearing, for example, stick packaging or aluminum envelopes.



## GRW quality: internationally certified DIN EN ISO 9001

GRW is an international enterprise specializing in development and production of high-precision miniature ball bearings. Ensuring our customers complete satisfaction is our top priority. By continually improving our products and processes, we ensure the long-term success of our company.

To achieve these goals we introduced a management system that evolves with the future requirements of each market. Our corporate strategy, based on growth and innovation, is the basis for a successful partnership with our customers and suppliers.

Our integrated management system is based on DIN EN ISO 9001:2008 and is certified in four specific areas:

1. Organizational Manual
2. Key Performance Indicators (KPI)
3. Process Definitions and Defined Responsibilities
4. Process Control Documentation (work and test instructions) including supporting documents (e.g. quality check lists, forms)

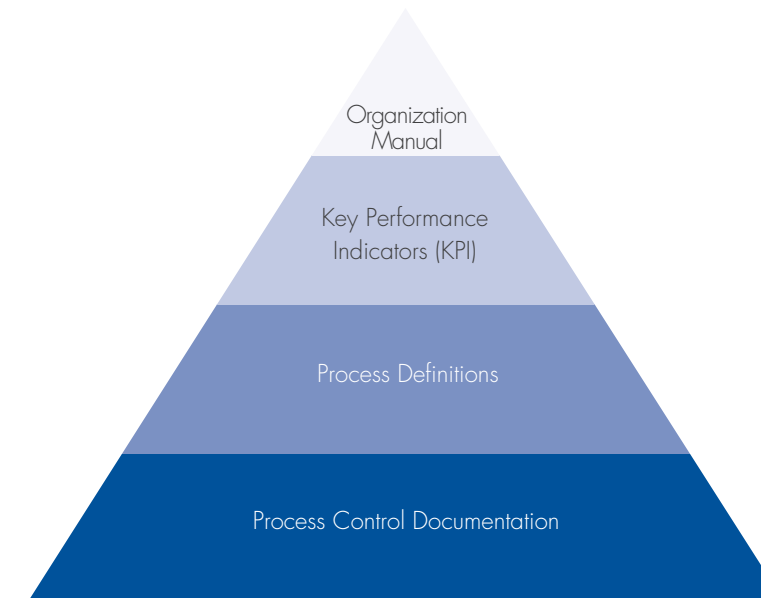

The Organizational Manual includes a Management section addressing our customers, employees and suppliers. It contains our corporate principles and corporate policy. Special sections contain job descriptions and Key Performance Indicators. These critical areas of measurement contain the controlling documentation for organizational process and product quality as well as continuous improvement.



# Manufacturing in a Nut Shell

GRW high-precision ball bearings are used in a variety of industries and applications.

Before they leave our factory, they have passed several complex manufacturing steps.

Their journey starts in the turning department where our high-precision turning machines produce bearing rings from a variety of steels used by GRW.



Turning department



Customized

since 1942.

After heat treat, all critical dimensions and raceway geometries are precisely machined to the micron ( $\mu$ ). Interim quality measurements are made in the measurement room



Measurement room



Grinding department



Honing department

Honing is the last step before assembly. The finished, bearing rings run through a final process on machines co-developed by GRW for surface finishing of the raceways.

During the final assembly, finished components are sorted and selected to guarantee customer satisfaction and in some cases automated assembly can be used to assemble, lubricate and package bearings.

# Index

Accessories	84-87	Materials	4, 83
Angular contact bearings	58	Materials for rings and balls	4
Axial clearance	18	Mating surfaces	10
Axial runout	10	Noise testing	24
Axial vibration test GPA	24	O configuration	60-61
Axial yield	17	Oils	8, 83
Bearing abbreviations	62	Operating speed	16
Bearing terms	62	Orakel III	88
Bearing tests	94-95	Outside diameter	19
Bearing types	62	Packaging	92
Bearing units	73	Packings	5, 72
Bore circlips	86	Preface	3
Bore diameter	19	Profile rollers	72
Ceramic ball bearings	75	Quality	93
Certification	93	Radial play	18, 20
Classification of radial play	23	Radial yield	17
Closures	5, 58	Rating life	14, 15
Coated bearings	78	Reduction in radial play	20-22
Coating	78	Reference speed	16
Code calibration	19	Retainers for miniature ball bearings	6-7
Contact angle	18	Running accuracy	12, 26-29
Curvature	14, 18, 83	Shaft circlips (VSR)	86-87
Deep groove radial bearings - metric	30-51	Shape accuracy	26-29
Deep groove radial bearings - inch	52-57	Shims (AS)	84
Deformation, axial, radial	17	Snap retainer	6
Designation system for radial ball bearings	Cover	Solid retainer	6, 7
Designation system spindle ball bearings	62-63	Special bearings	76-77
Dimensional accuracy	26-29	Special installation configurations	11
Duplex ball bearings	59	Special treatment	8, 9
Duplexed bearings	59-60	Special variants	75-78
Dynamic imbalance	26-29	Speedmaster	88
Dynamic radial load rating	14	Spindle bearings	58, 62-71
Elastic behavior of deep groove radial bearings	17	Spring washers (WF)	84
Equivalent load, radial load	14	Starting torque	25
Fitting Tolerances	12-13	Static equivalent radial load	14
Flanged ball bearings, installation	11	Static radial load rating	14
Flanged ball bearings, types	11	Tandem configuration	60
Friction test	24	Tandem pairing	60
Friction torque	24-25	Thin-section bearings	74
Full ceramic ball bearings	75	Tilt angle	18
Full complement ball bearings	7	Tolerances for ball bearings	26-29
Functional tests	24-25	Tolerances for shaft and housing	13
Greases	8-9	Universal configuration	60
Grading of bore and outside diameter	19	Vibration testing	24
Handling of ball bearings (duplexed bearings)	59-60	X configuration	60
Handling of ball bearings	90-91	<b>XTRA</b> special program	79-83
Hybrid ball bearings	4, 12, 75	<b>XTRAc Coat</b>	78-81
Installation and configuration of Duplex ball bearings	60	<b>XTRAlon</b>	6-7, 82
Laboratory services	89	<b>XTRAlube</b>	9, 81
Limiting speeds	14, 16, 83	<b>XTRAlub</b>	6
Load ratings and L-10 Life	14	<b>XTRAlub</b>	6
Lubricants	8	Yield, axial, radial	17

About us:  
GRW  
Gebr. Reinfurt GmbH & Co. KG  
Niederhoferstraße 105  
D-97222 Rimpar  
P.O. Box 142  
D-97219 Rimpar

phone: +49 (0) 93 65/819 - 0  
fax: +49 (0) 93 65/819 - 100  
e-mail: [info@grw.de](mailto:info@grw.de)  
web: [www.grw.de](http://www.grw.de)

Kommanditgesellschaft (Limited Partnership)  
headquartered in Würzburg  
Register Court: Würzburg HRA 467  
Personally liable partner:  
Verwaltungsgesellschaft Reinfurt mbH  
headquartered in Würzburg  
Register Court: Würzburg HRB 196  
Sales tax ID: DE 811118985  
Managing Director: Michael Ludwig (Speaker),  
Klaus Bonaventura, Michael Wilhelm  
For our current General Terms and Conditions,  
please see: [www.grw.de](http://www.grw.de)  
Subject to errors and change without notice.  
All rights reserved.

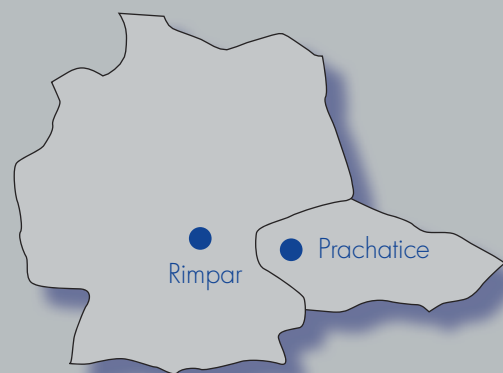
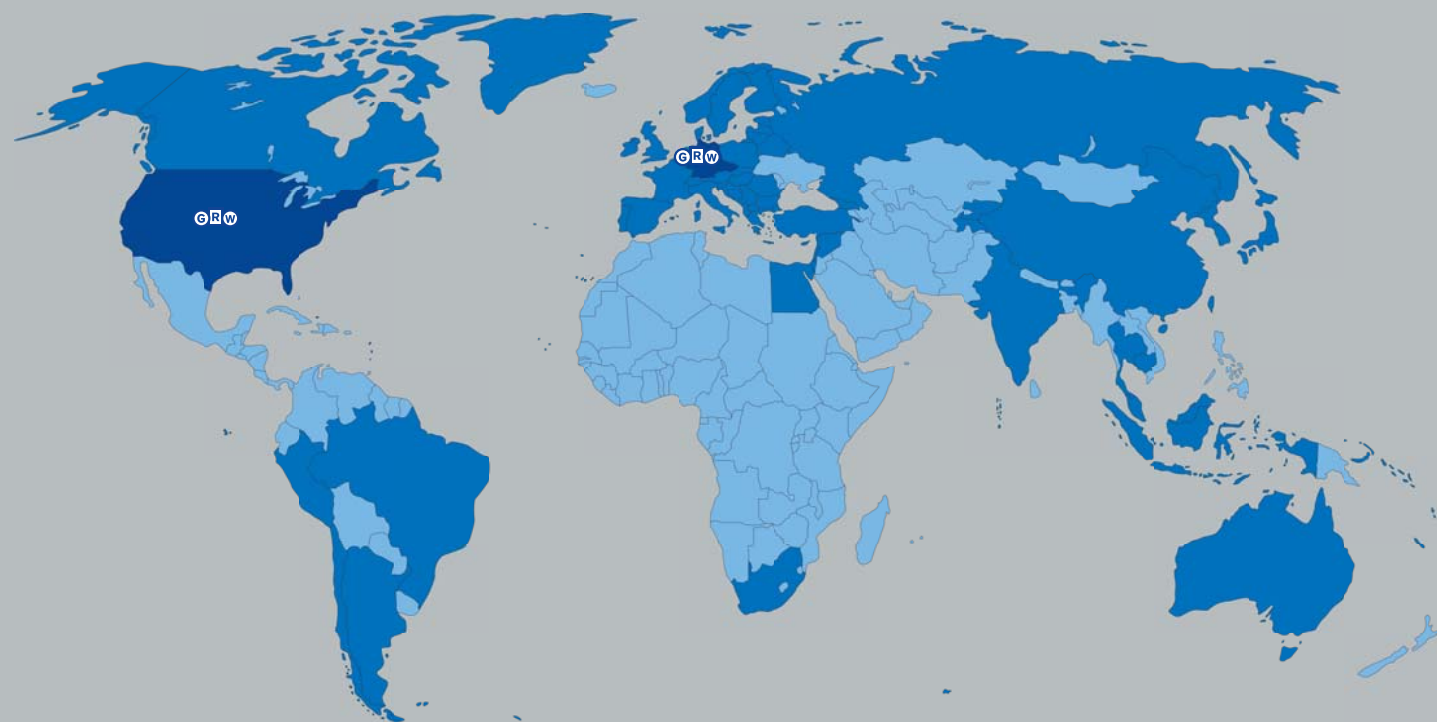

Headquarter & production, Rimpfing (GER)



Sales office, Richmond – Virginia (USA)



Production site, Prachatitz (CZ)

**GEBR. REINFURT GMBH & CO. KG  
HOCHPRÄZISIONSKUGELLAGER**

Niederhoferstraße 105  
97222 Rimpfing  
Germany  
phone: +49 (0) 93 65/819 - 0  
fax: +49 (0) 93 65/819 - 100  
e-mail: [info@grw.de](mailto:info@grw.de)  
web: [www.grw.de](http://www.grw.de)

**GRW  
HIGH-PRECISION BALL BEARINGS LP**

530 Eastpark Court, Suite H  
Sandston, Virginia 23150  
USA  
phone: +1 (804) 328 0900  
e-mail: [info@grwbearing.com](mailto:info@grwbearing.com)  
web: [www.grwbearing.com](http://www.grwbearing.com)

**Reinfurt-ČR, k.s.  
HIGH-PRECISION BALL BEARINGS**

Průmyslová 1366  
383 01 Prachatitz  
Czechia  
phone: +420 380 601 039  
e-mail: [info@reinfurt.cz](mailto:info@reinfurt.cz)  
web: [www.grw.cz](http://www.grw.cz)